

# LUMINE

## LUMINE

PRÊT À PORTER READY-TO-WEAR



CONCEPT

# LE CONCEPT LUMINE

Avec le concept LUMINE, réaliser en même temps merchandising et éclairage devient possible. LUMINE est un système alliant des crémaillères rendues conductrices et des tablettes devenues lumineuses. LUMINE ré-enchant le parcours consommateur en apportant fraîcheur, élégance et en soulignant la couleur des produits au travers de leur mise en scène. L'ambiance ainsi créée suscite des émotions qui permettent d'augmenter la probabilité de concrétisation de l'acte d'achat. LUMINE est la solution de merchandising idéale pour un agencement de magasin identitaire et créateur de business.

## LUMINE CONCEPT

*With LUMINE, you can easily manage both merchandising and lighting. This new concept is composed of electrified slot-channels and support tablets transformed into luminaires.*

*LUMINE enhances customer journey bringing freshness and elegance while highlighting product colour through their staging. This new ambiance evokes emotions that increase probability to materialise the act of purchase.*

*LUMINE is the ideal merchandising solution that create an inspired and remarkable store's interior design to generate business and participate to its growth.*

"L'Expérience  
Shopper Optimale"

"The Optimal  
Shopper Experience"



1

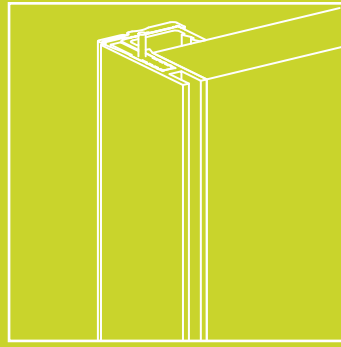

Crémaillère d'extrémité électrifiée avec panneau de 19 mm / Electrified lateral slot channel with 19mm panel



2

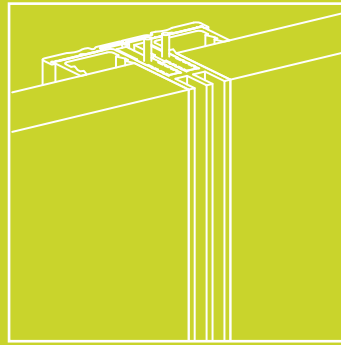

Crémaillère double perforation électrifiée avec panneau de 19 mm / Electrified double-slot channel with 19mm panel

## CRÉMAILLÈRES ÉLECTRIFIÉES

- 1 - Crémaillère d'extrémité
- 2 - Crémaillère double perforation

### ELECTRIFIED SLOT CHANNELS

- 1 - Lateral slot channel
- 2 - Double-slot channel

## Eclairer ...

Un système prêt à poser de crémaillères d'habillage mural électrifiées.

## Lighting ...

A simple and complete system of electrified paneling cladding slot channels ready to hang.



## SUPPORT

Support pour tablette verre épaisseur 6 mm et pour tablette bois épaisseur 19 mm

## BRACKET

Bracket for 6mm glass shelf or 19mm wood shelf

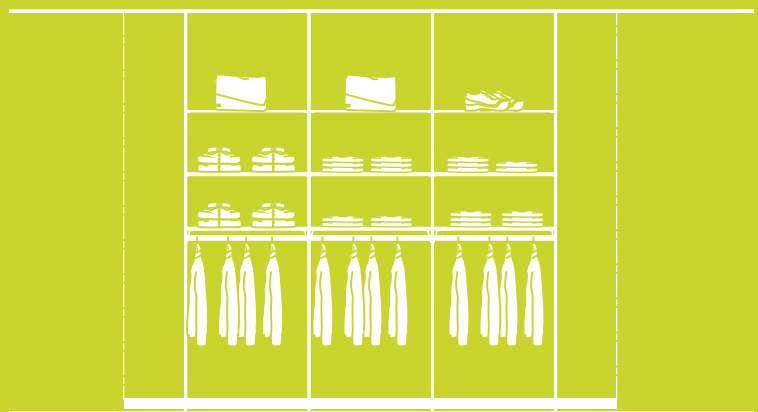

## ... pour dynamiser le merchandising

La connexion et l'éclairage se font par la seule accroche des supports sur les crémaillères.

## ... to ensure a dynamic merchandising

you only have to fix the bracket on the slot channel to connect and light the system.



## DESIGN

La discrétion des crémaillères et l'élégante sobriété des accessoires LUMINE ont été pensées pour une mise en valeur optimale du produit par la lumière. L'association des crémaillères double perforation et des tablettes affleurantes permet d'optimiser la surface utile et de sublimer l'espace de présentation alloué.

Le concept LUMINE offre une gamme complète d'accessoires, modulaire et design, pour un agencement sur-mesure changeant au gré des collections. Une multitude de combinaisons pour une mise en scène toute en contraste et un parcours consommateur guidé et incité.

## DESIGN

*Designed to enhance product with light, LUMINE's accessories are discreet and elegant.*

*Thanks to its slot-channels double perforation concept and their flush support tablets, we can optimise usable area and work on sublimate dedicated product's spaces.*

*LUMINE offers a complete range of modular and design accessories for a tailored fitting out store that can evolve depending on collections and seasons. A broad array of configurations to enhance, all in contrast, a guided and prompted customer journey.*



## + PRODUIT

- Connection simple en plug and play
- Electrification invisible
- Mise en œuvre traditionnelle des crémaillères
- Fixation des panneaux par clips invisibles ou taquets

## PRODUCT +

- Simple connection plug and play
- Invisible electrification
- Usual fixation of the slot channels
- Fixation of panels with invisible clips or cleats



## MATIÈRE/FINITION

	Matières	Finitions
Crémaillère	Aluminium	AS : Anodisé Argent Satiné
Support	Acier	Laqué

## MATERIAL/FINISH

	Material	Finish
Slot channel	Aluminium	AS: Satin silver anodized
Bracket	Steel	Powdercoated



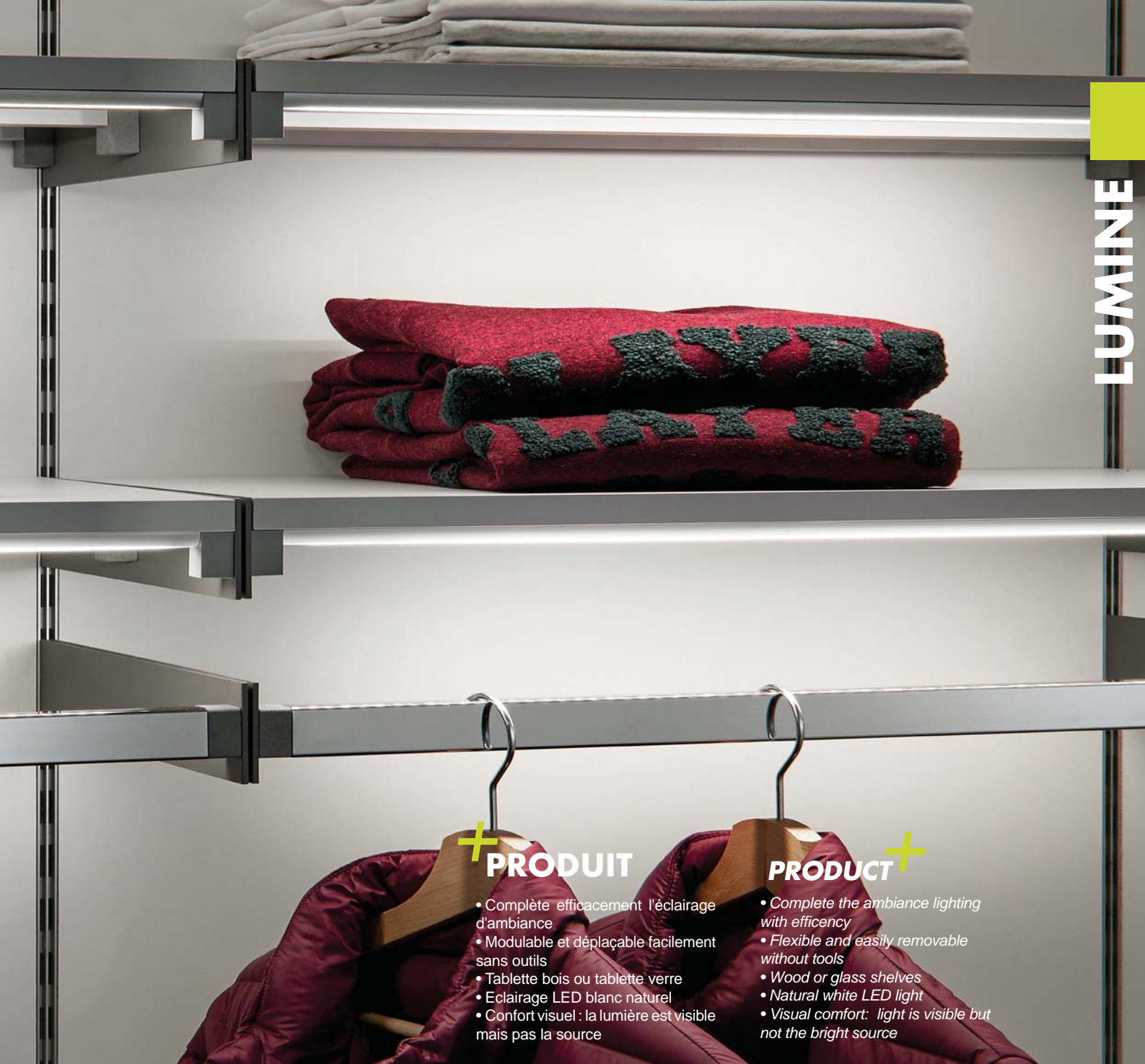

## + PRODUIT

- Complète efficacement l'éclairage d'ambiance
- Modulable et déplaçable facilement sans outils
- Tablette bois ou tablette verre
- Eclairage LED blanc naturel
- Confort visuel : la lumière est visible mais pas la source

## + PRODUCT

- Complete the ambient lighting with efficiency
- Flexible and easily removable without tools
- Wood or glass shelves
- Natural white LED light
- Visual comfort: light is visible but not the bright source





1



2



3

- 1 - Barre penderie  
*Clothes rail*
- 2 - Support pour tablette bois  
*Bracket for wood shelf*
- 3 - Support pour tablette verre  
*Bracket for glass shelf*
- 4 - Tableau lumineux  
*Luminous table*

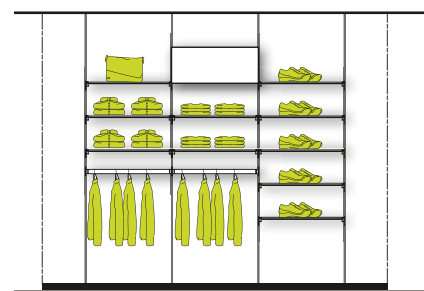
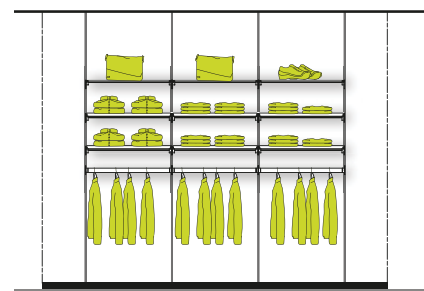
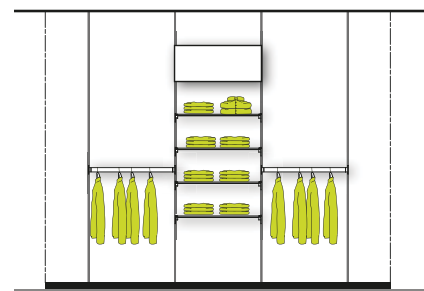



4

## + PRODUIT

Le tableau lumineux :

- Renforce la visibilité d'une partie du merchandising.
- Permet le rétroéclairage de produits posés sur tablette.
- Peut être utilisé comme support de communication.

## PRODUCT +

Lighting panel:

- Reinforces visibility on merchandising
- Allows product's backlight
- Can be used as communication tool



**Crémaillère habillage double perforation électrique**

Double-slot panelling channel electric

Longueur / Length: 2975 mm

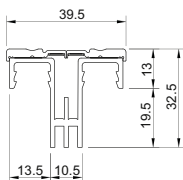
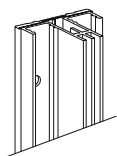

• Réf / Art. no. 29CR0129

**Crémaillère habillage d'extrémité électrique**

Lateral panelling channel electric

Longueur / Length: 2975 mm

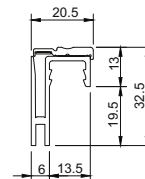
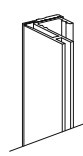

• Réf / Art. no. 29CR0229

**Taquet d'extrémité**

Lateral cleat

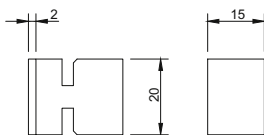

• Réf / Art. no. 283003

**Fixateur moyenne resistance**

Medium-resistance clip

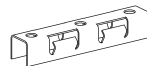

• Réf / Art. no. FCR12MDB

**Gabarit pour fixateur FCR12MD (6 mm)**

Template for clip FCR12MD (6 mm)

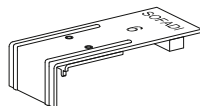

• Réf / Art. no. GABMD1

**Kit support pour tablette bois 19 mm éclairante**

Pair of brackets for 19mm wood lighting shelf

Longueur / Length: 300 mm  
Entraxe / Centre width: 600 mm

Charge maxi. / Safe load: 20 kg

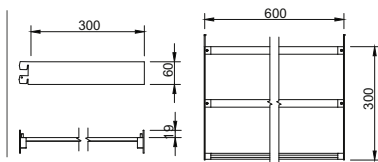
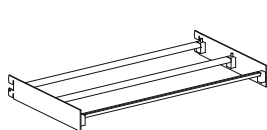

• Réf / Art. no. 29SU03-B

**Kit support pour tablette verre 6 mm éclairante**

Pair of bracket for 6mm glass lighting shelf

Longueur / Length: 300 mm  
Entraxe / Centre width: 600 mm

Charge maxi. / Safe load: 20 kg

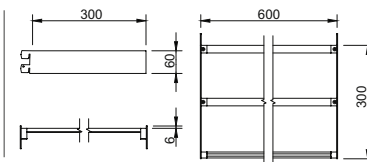
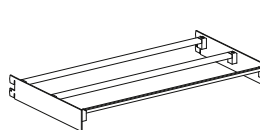

• Réf / Art. no. 29SU03-V

**Kit 2 connecteurs "+/-" avec fil**

Kit of 2 connectors "+/-" with cable

Longueur / Length: 1500 mm

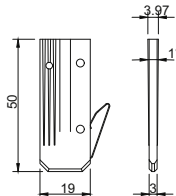
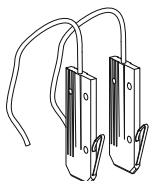

• Réf / Art. no. 29EC01

**Transformateur alimentation LED 12V 60W IN120-240V**

Alimentation transformer LED 12V 60W IN120-240V

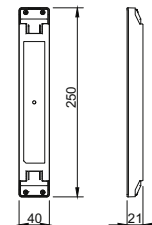
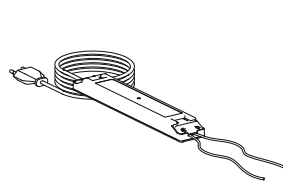

• Réf / Art. no. 29ET01

**Paire support pour barre penderie 30x15 mm**

Pair of clothes rail brackets 30 x 15 mm

Profondeur / Standout: 300 mm

Charge maxi. / Safe load: 20 kg

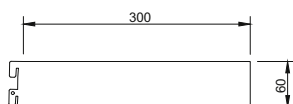
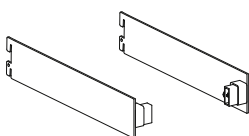

• Réf / Art. no. 29SU08

**Barre penderie 30x15 mm**

Clothes rail 30 x 15 mm

Longueur / Length: 600 mm

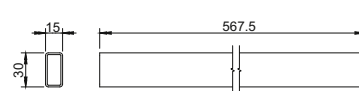
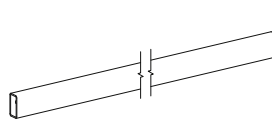

• Réf / Art. no. 29BP0106

ATTENTION : La charge maximale est indiquée par tablette. Veuillez à toujours répartir la charge de façon homogène sur l'ensemble des supports ou des tablettes.  
CAUTION: The safe load is specified per shelf. Loads must always be evenly distributed over the brackets or shelves

## Kit tableau lumineux

Kit luminous table

Longueur / Length: 603 mm

Hauteur / Height: 250 mm

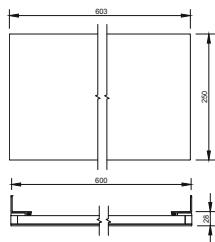
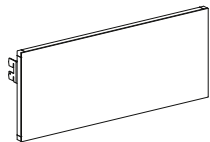

• Réf / Art. no. **29PL02**

# TECHNIQUE LUMINE

## LUMINE TECHNIQUE

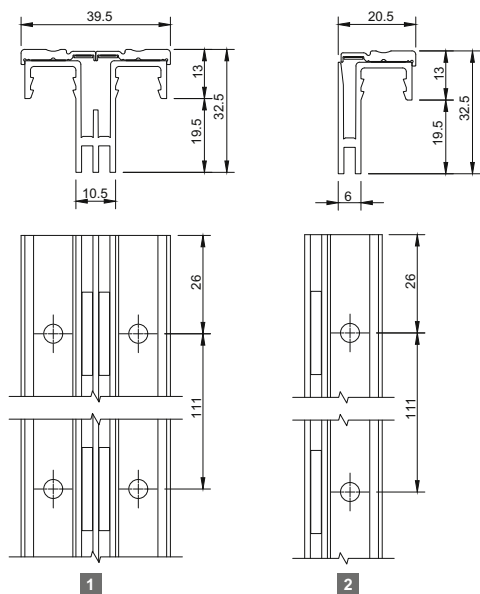

### CRÉMAILLÈRES

- 1 - Crémallière d'habillage double perforation électrique - réf : 29CR0129
- 2 - Crémallière d'habillage d'extrémité électrique - réf : 29CR0229

### SLOT CHANNELS

- 1 - Double-slot panelling channel electric - Art. no. 29CR0129
- 2 - Lateral panelling channel electric - Art. no. 29CR0229

## MISE EN ŒUVRE / INSTALLATION

### SYSTÈME PAR CLIP / CLIP SYSTEM

Coupes de principe  
Typical sections

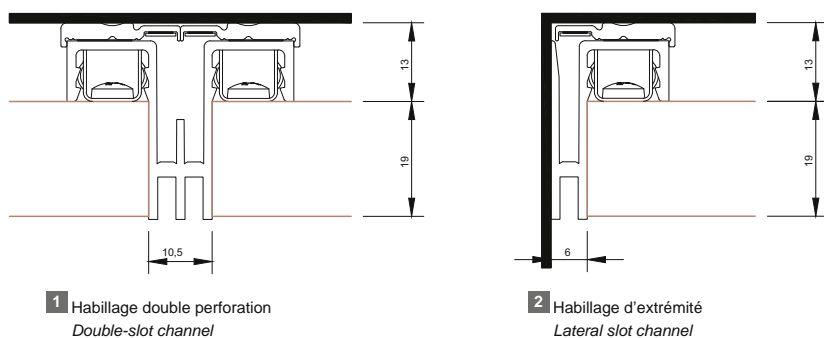

1 Habillage double perforation  
Double-slot channel

2 Habillage d'extrémité  
Lateral slot channel

### SYSTÈME PAR TAQUET / CLEAT SYSTEM

Coupes de principe  
Typical sections

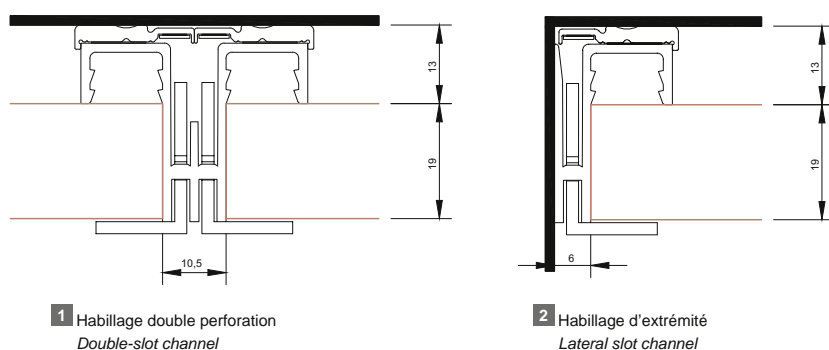

1 Habillage double perforation  
Double-slot channel

2 Habillage d'extrémité  
Lateral slot channel

# MISE EN ŒUVRE / INSTALLATION

## SYSTÈME CRÉMAILLÈRE / SLOT CHANNEL SYSTEM

Principe du respects des polarités

Polarities respects principle

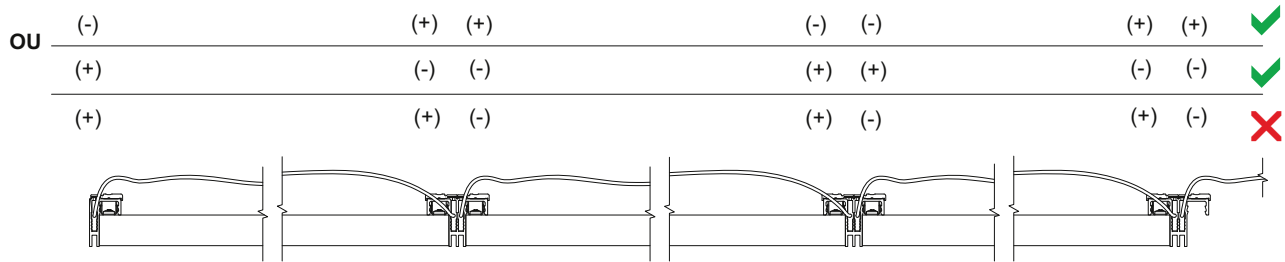

Principe de montage

Configurations

Exemple

Example

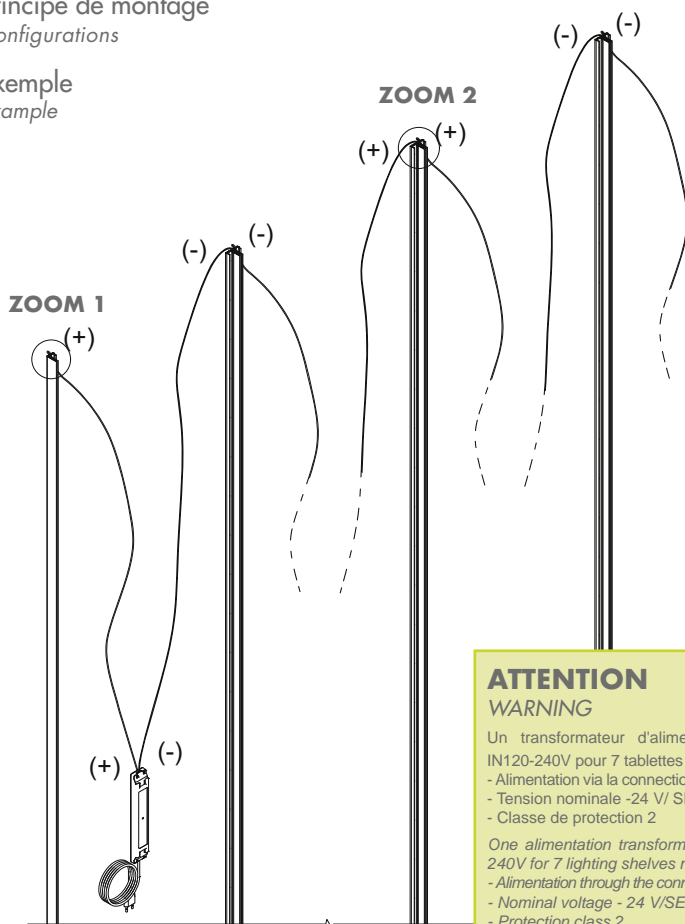

Éclairage lumineux

Illuminance

- Blanc naturel 4000 k
- Tablette Longueur 600 mm 7,2 W
- Natural white 4000 k
- Shelf length 600mm 7,2W

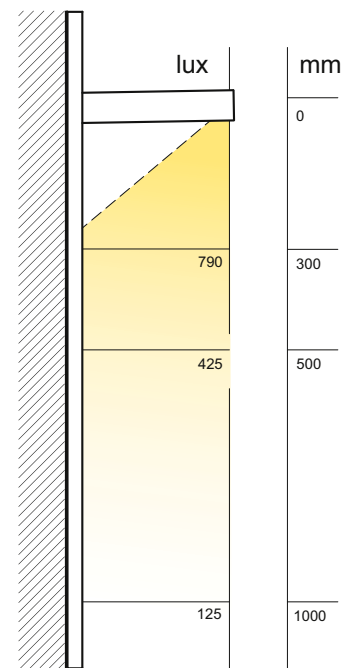

### ATTENTION WARNING

Un transformateur d'alimentation LED 12V 60W IN120-240V pour 7 tablettes lumineuses maximum.

- Alimentation via la connection pour câble d'alimentation
- Tension nominale - 24 V/SELV
- Classe de protection 2

One alimentation transformer LED 12V 60W IN120-240V for 7 lighting shelves maximum.

- Alimentation through the connection for alimentation cable
- Nominal voltage - 24 V/SELV
- Protection class 2

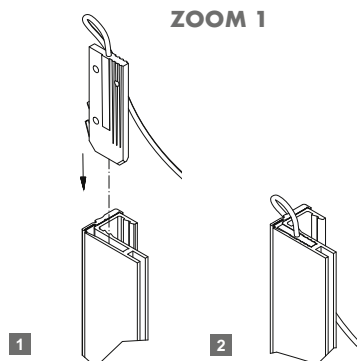
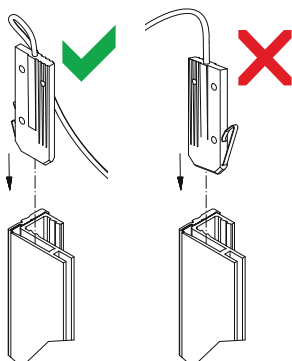

Sur crémaillière d'extrémité  
Lateral channel

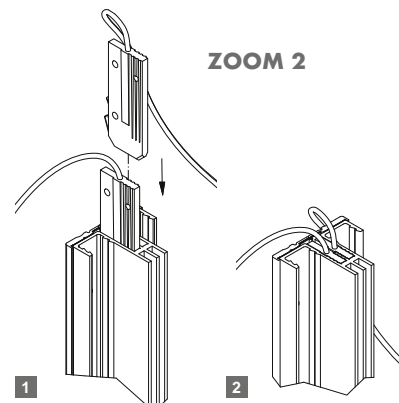

Sur crémaillière double  
Double-slot channel

# TECHNIQUE LUMINE

## LUMINE TECHNIQUE

### MISE EN ŒUVRE / INSTALLATION

Kit supports pour tablette bois  
Pair of brackets for wooden shelf

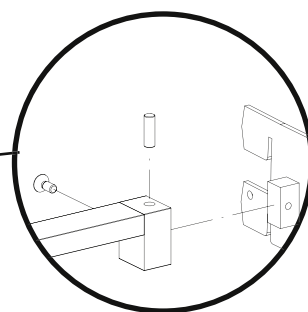
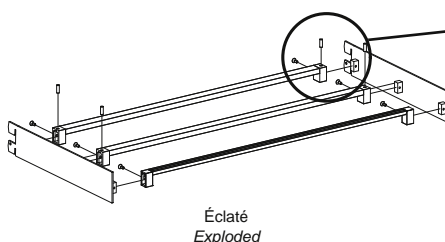
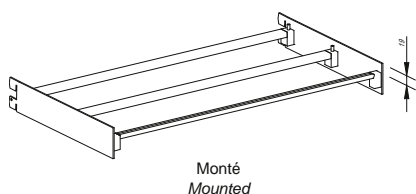

Kit supports pour tablette verre  
Pair of brackets for glass shelf

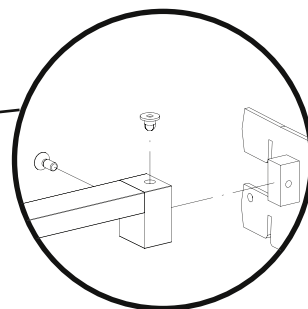
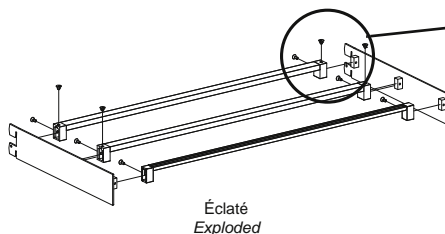
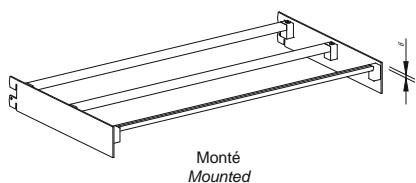

### AVERTISSEMENTS DE SÉCURITÉ

#### SECURITY WARNINGS

- La sécurité et la garantie du produit ne sont assurés qu'en cas d'usage conforme à nos prescriptions. Dans le cas contraire nous déclinons toute responsabilité.
- Respecter impérativement les indications notées sur les étiquettes et / ou emballages notamment concernant le transformateur.
- N'utiliser que des accessoires LUMINE à l'exclusion de tout autres accessoires ou systèmes.
- Les profils et accessoires LUMINE ne peuvent être modifiés. Seule la coupe pour mise à dimension des crémaillères est admise.
- L'utilisateur reste seul responsable des vérifications de la compatibilité électrique et de la fixation mécanique des crémaillères.
- Aucun article présenté sur les tablette LUMINE ne doit contenir un liquide pouvant se déverser.
- Le nettoyage avec liquide déversé peut endommager le système LUMINE.

\* The product security and warranty are covered only in case of a conform use following our prescriptions. Otherwise, we disclaim any responsibility.

\* To respect imperatively the indications written on the labels and / or packaging especially for the transformer.

\* To use only LUMINE accessories with the exclusion of all other accessories or systems.

\* LUMINE profiles and accessories cannot be modified. Only the slot channels cut to size is accepted.

\* The user remains the only responsible of the electric compatibility controls and of the slot channels mechanical fixation controls.

\* No article presented on LUMINE shelves can contain liquid able to flow.

\* Flowing liquid on shelves for cleaning can damage the LUMINE system.



# PRÉCONISATIONS POUR LES TABLETTES

## RECOMMENDATIONS FOR SHELVES

### Dimensions tablettes verre

Glass shelf dimensions

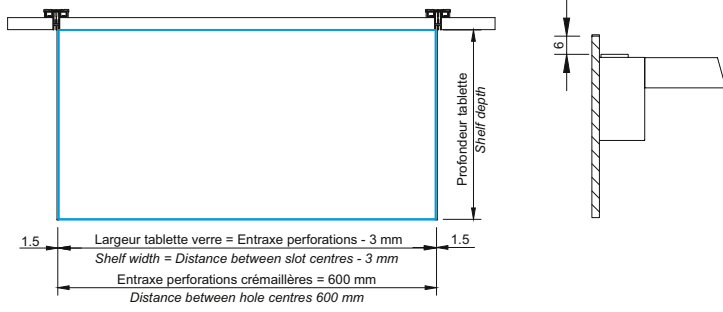

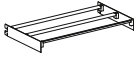
Schémas Sketch	Références Art. no.	Entraxe perforations 600 mm Distance between hole centres 600 mm
	29SU03-V	Largeur Width 597 mm Profondeur Standout 300 mm

### Dimensions tablette bois

Wood shelf dimensions

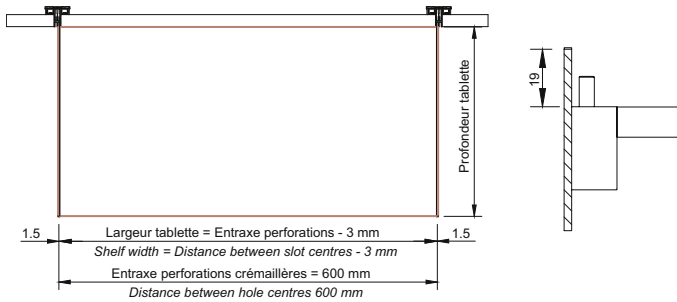

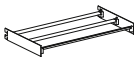
Schémas Sketch	Références Art. no.	Entraxe perforations 600 mm Distance between hole centres 600 mm
	29SU03-B	Largeur Width 597 mm Profondeur Standout 300 mm

