















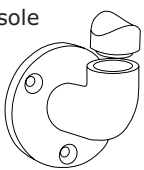

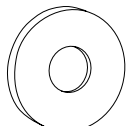
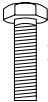
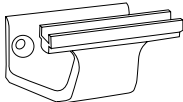

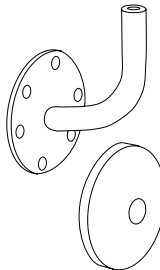
Instructions de montage

BIO FORM 40 ALUMINIUM ANODISÉ

MAIN COURANTE tubulaire Ø40
ALUMINIUM ANODISÉ

<p>EMBOUT STANDARD</p>  x 1	<p>EMBOUT D'ANGLE EXTERNE OU INTERNE</p>  x 1	<p>EMBOUT D'ANGLE UNIVERSEL (95° À 170°)</p>  x 1
<p>BOUCHON D'EXTRÉMITÉ</p>  x 1 <p>Bague décorative noire</p>  x 1 <p>Vis TCL 6 x 16 cruciforme</p>  x 1	<p>CONSOLE ACROVYN</p> <p>console x 1 collerette x 1</p>   x 1 <p>cache vis x 1</p>  x 1 <p>Vis TH inox HM 12 x 40 Pas 1,75</p>  x 1 <p>3 points de fixation (visserie non fournie) Tous les 800 à 1000 mm</p>	<p>CONSOLE DESIGN EN ALUMINIUM ANODISÉ</p>  x 1 <p>Vis STHC BT Plat M5 x 12</p>  x 2 <p>2 points de fixation (visserie non fournie) Tous les 800 à 1000 mm</p>
<p>CONSOLE EN ACIER INOXYDABLE FINITION BROSSÉE</p>  x 1 <p>MCE Tête alu x 1</p>  x 1 <p>Vis FHc 90 M5 x 20</p>  x 1 <p>Cache vis x 1</p>  x 1 <p>Vis STHC Bout conique M5 x 8</p>  x 1 <p>6 points de fixation Ø 7 (visserie non fournie) Tous les 800 à 1000 mm</p>	<p>KIT DÉMONTABLE POUR GAINÉ TECHNIQUE</p>  x 2 <p>Bouton Auvergne M5 x 10</p>  x 4	<p>ECLISSE DE RACCORDEMENT</p>  x 1 <p>Vis STHC BT Plat M5 x 12 HC Brut</p>  x 2
<p>PROFILÉ ACROVYN en 4 ml avec film de protection temporaire</p> 		<p>PROFILÉ ALUMINIUM BRUT en 4 ml</p>  <p>PARE-CLOSE TRANSLUCIDE EN 4 ML</p> 

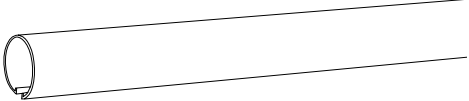
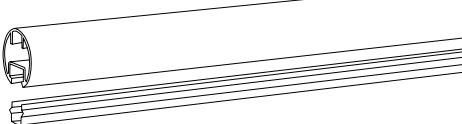
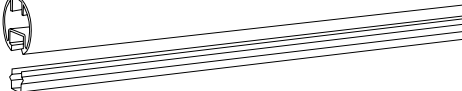
C/S FRANCE

135 rue Edouard Isambard – B.P. 66 – F 27120 PACY SUR EURE CEDEX

Tél. : 02.32.67.00.00. - Fax : 02.32.67.14.12.

www.cs-france.fr

NOVEMBRE 2011

Instructions de montage

BIO FORM 40 ALUMINIUM ANODISÉ

**MAIN COURANTE tubulaire Ø40
ALUMINIUM ANODISÉ**

MISE EN ŒUVRE

1- Relever la longueur à équiper.

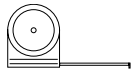

2- Couper à la longueur désirée en tenant compte des déductions suivantes :

1 Embout standard	92 mm
1 Embout externe	0 mm
1 Embout interne	92 mm
1 Embout bouchon	4 mm

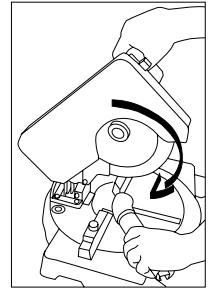
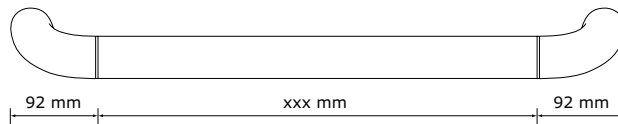

3- Montage des consoles

3-1 Console Acrovyn

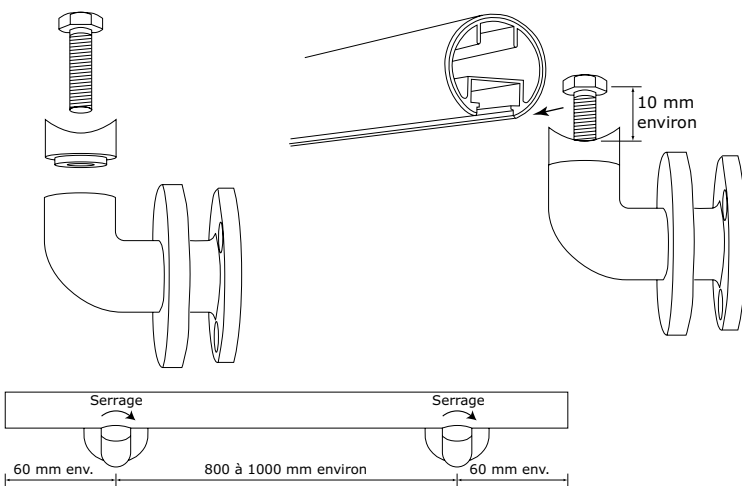

3-2 Console design en aluminium anodisé

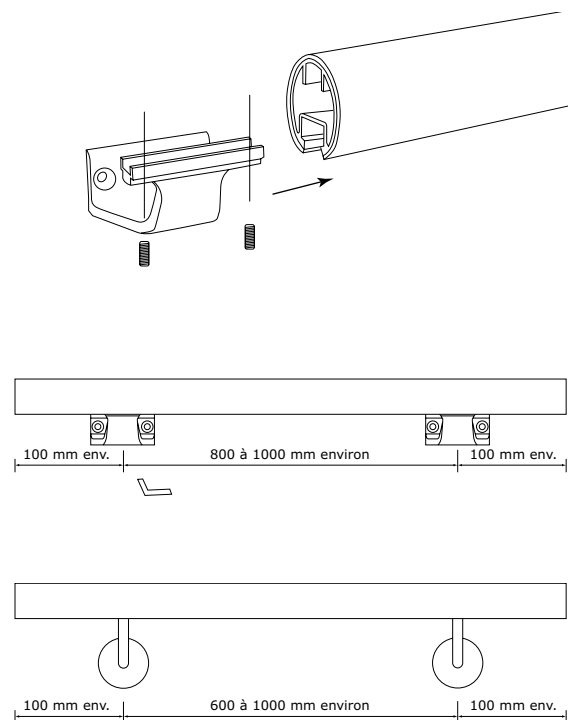

3-3 Console design en acier inoxydable

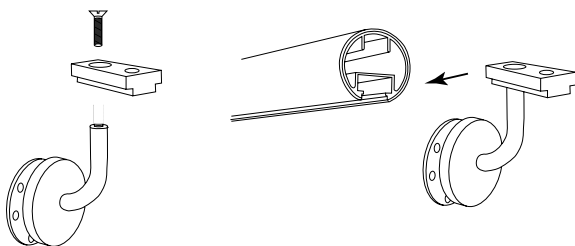

4- Montage des embouts standards

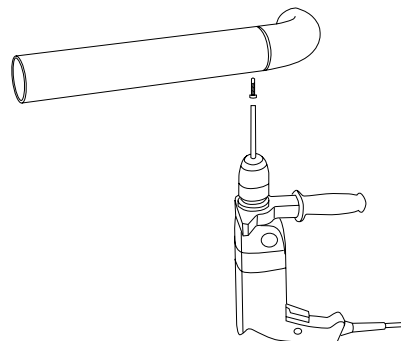
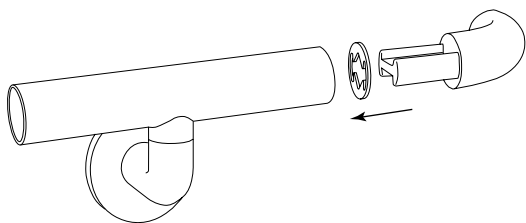

5- Couper la pare-close à longueur.
Insérer la dans le logement inférieur du support aluminium entre les consoles et entre consoles et embouts.

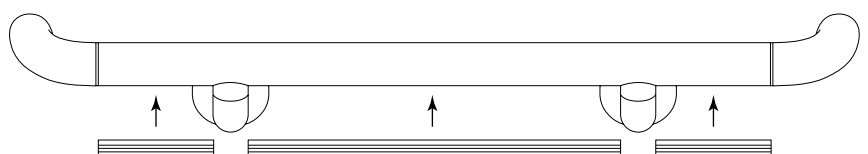

Instructions de montage

BIO FORM 40 ALUMINIUM ANODISÉ

MAIN COURANTE tubulaire Ø40 ALUMINIUM ANODISÉ

6- Fixation au mur :

6-1 Console Acrovyn.

Repérer la ligne de point bas des consoles.
Positionner la main courante pré-assemblée sur le mur en fonction des repères tracés, vérifier le niveau.
Soulever les cache-vis, tracer les trous de fixation, percer.
L'installateur choisira le mode de fixation adapté aux différents supports rencontrés.
Visser.
Clipser le cache vis.

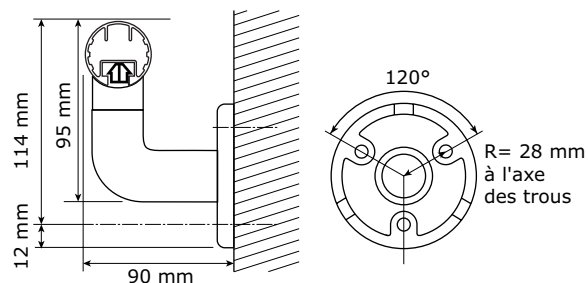

6-2 Console design en aluminium anodisé.

Repérer l'axe des fixations des consoles aluminium.
Positionner la main courante pré-assemblée sur le mur en fonction de la ligne tracée, vérifier le niveau.
Tracer les trous de fixation, percer.
L'installateur choisira le mode de fixation adapté aux différents supports rencontrés.
Visser.

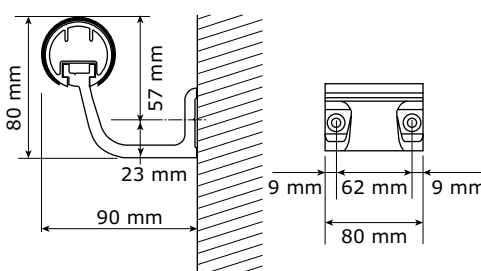

6-3 Console en acier inoxydable.

Repérer la ligne de point bas des consoles.
Positionner la main courante pré-assemblée sur le mur en fonction des repères tracés, vérifier le niveau.
Soulever les cache-vis, tracer les trous de fixation, percer.
L'installateur choisira le mode de fixation adapté aux différents supports rencontrés.
Visser.
Clipser le cache vis.

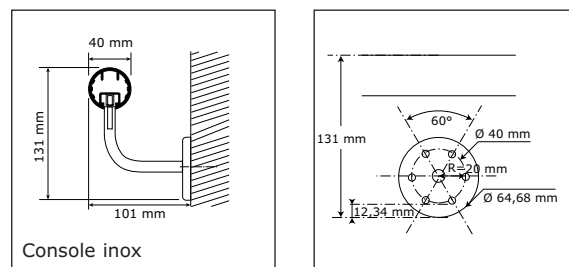

6-4 Retirer le film de protection temporaire.

7- Cas particuliers

7-1 Montage d'une éclisse (longueur supérieure à 4 ML)

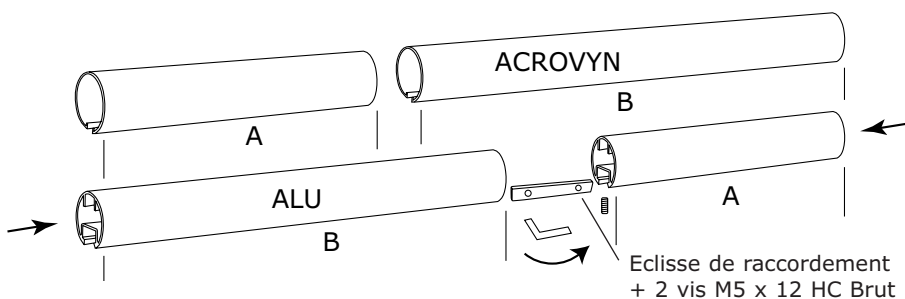

7-2 Kit démontable pour gaine technique

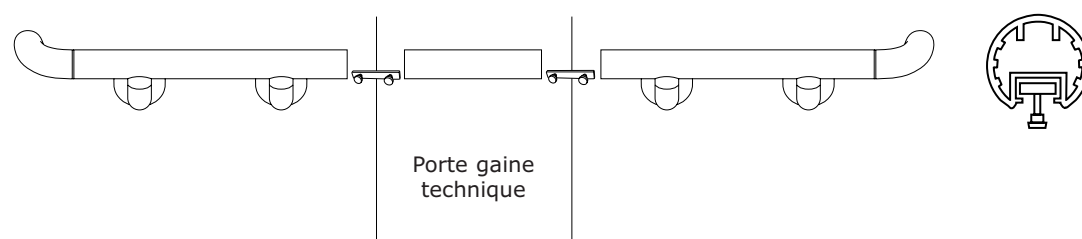

Instructions de montage

BIO FORM 40 ALUMINIUM ANODISÉ

MAIN COURANTE tubulaire Ø40 ALUMINIUM ANODISÉ

7-3 Embout universel pour angles spéciaux

MISE EN ŒUVRE

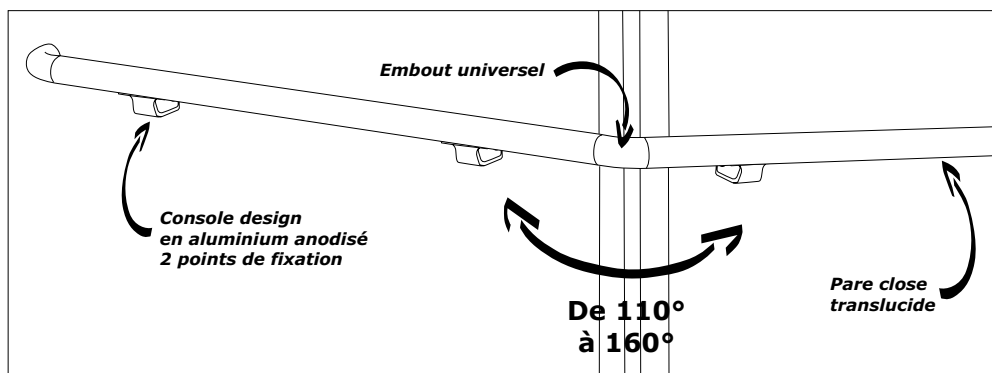
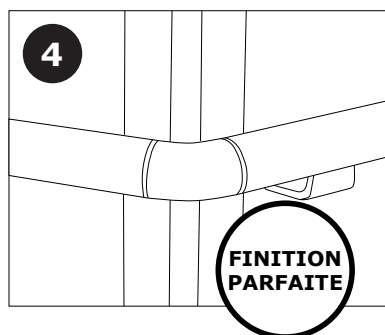
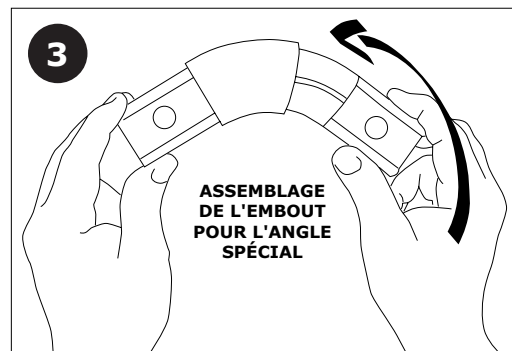
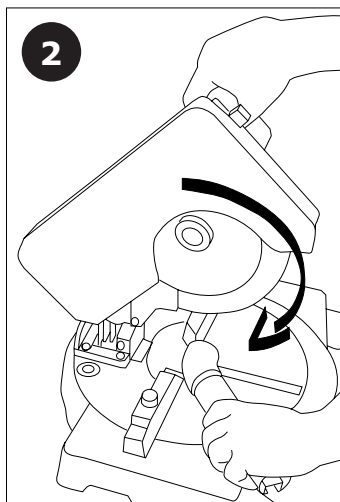
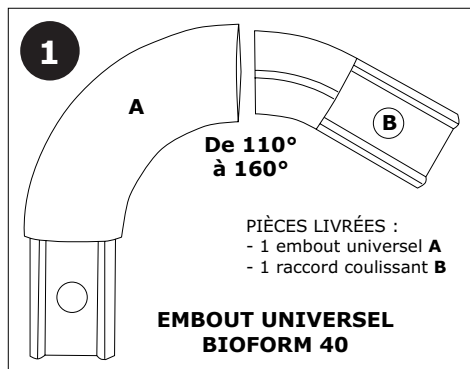

8- Exemple de réalisation

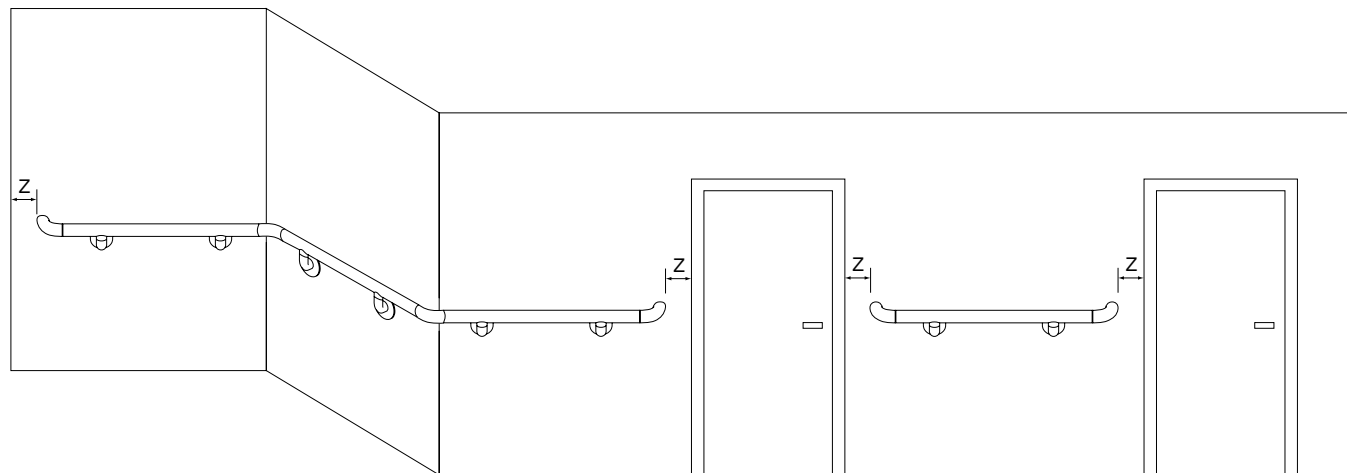

Jeu "Z" à déterminer