

FAR TOOLS®



CH 500
Professional Machine

© FAR GROUP EUROPE

FR	Clé à choc (Notice originale)
EN	Impact wrench (Original manual translation)
DE	Schlagschrauber (Originalbetriebsanleitung)
ES	Atornillador de impacto (Traducción del manual originale)
IT	Avvitatrice ad urti (Traduzione dell'avvertenza originale)
PT	Aparafusadora de percussão (Tradução do livro de instruções original)
NL	Slagschroevendraaier (Vertaling van de originele instructies)
EL	Κρουστική μηχανή βιδώματος (Μετάφραση από τις πρωτότυπες οδηγίες)
PL	Wkrętarka udarowa (Tłumaczenie z oryginalnej instrukcji)
FI	Iskuruuvaava porakone (Käännös alkuperäisestä ohjeet)
SV	Slagskruddragare (Översättning från originalinstruktioner)
BU	машина за завинтване с удар (Превод на оригиналната инструкция)
DA	Stødskruemaskine (Oversættelse fra oprindelige brugsanvisning)
RO	Mașină de înșurubat electro-pneumatică (Traducere din instrucțiunile originale)
RU	ударный шуруповерт (Перевод с оригинальной инструкции)
TU	Soklu vidalayıcı (Orijinal talimatlar çeviri)
CS	Nárazová uzavíračka (Překlad z originálního návodu)
SK	Nárazový uzatvárač (Preklad z originálneho návodu)
HE	תיורוקמ תוארוהמ סוגרת) סימלה הגרבמ
AR	آلة لاصول تاميل عتلا زم قم عرتلا) قباطحل راشزيم
HU	Elektropneumatikus csavarozó (Fordítás az eredeti utasítások)
SL	Udarni vijačnik (Prevod iz izvornih navodil)
ET	Löökjõuga kruvikeeraja (Tõlge originaal juhiseid)
LV	Elektriskais skrūvgriezis (Tulkojumā no instrukcijas oriģinālvalodā)
LT	Smūginis tvirtinimo aparatas (Vertimas iš originalių instrukcijas)
HR	Odvijač za bežični šok (Prijevod prema originalne upute)



115005-Manual-A-20220919



fartools.com

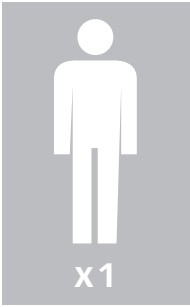

5 min





Description et repérage des organes de la machine
Description and location of machine parts

A



Contenu du carton
Contents of box

B



Points de collecte sur www.quafairendechets.fr
Privilégiez la réparation ou le don de votre appareil !







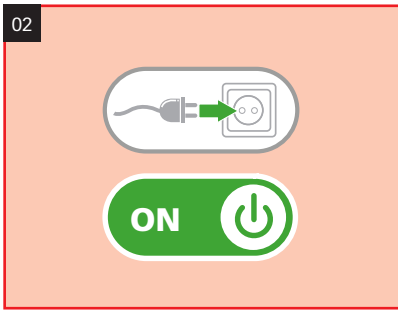

Fonctionnalité de la machine
Functions of the machine

D

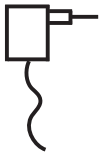



	<p>Tension et fréquence assignée: Nominal frequency and power: Spannung und Frequenz: Tensión y frecuencia fijada: Tensione e frequenza assegnata: Tensão e frequência fixa: Aangewezen spanning en frequentie: Ονομαστική τάση και συχνότητα: Napięcie i częstotliwość przydzielona: Jännite ja määrätty taajuus: Angiven spänning och frekvens: Anført spænding og frekvens: Tensiune și frecvență de lucru:</p>	<p>Заданное напряжение и частота: Tahsis gerilimi ve frekans: Stanovené napětí a frekvence: Stanovené napätie a frekvencia: מתח ותדר מוקצב. الفيلطية والذبذبة المبرمجة. Névleges feszültség és frekvencia: Napetost in določena frekvenca: Консумирано напрежение и честота : Määratud pinge ja sagedus Nustatyta įtampa ir dažnis Noteiktais spriegums un frekvence. Napon i nazivna frekvencija:</p>	230 V ~ 50 Hz
---	---	--	---------------

	<p>Puissance assignée: Nominal power: Nennleistung: Potencia fijada: Potenza assegnata: Potência assinada: Onbelast toerental: ΟΝΟΜΑΣΤΙΚΗ ΙΣΧΥΣ: Prędkość na biegu jałowym: Teho: Angiven effekt: Anført styrke: Putere de lucru:</p>	<p>Заданная мощность: Tahsis edilen güç: Stanovený príkon: Predpísaný výkon: Merkeeffekt: القدرة المبرمجة. Névleges teljesítmény : Določena jakost: Консумирана мощност: Määratud võimsus. Nustatyta galia Noteiktā jauda Nazivna snaga:</p>	710 W
---	---	--	-------

	<p>Classe d'isolement : 2 Insulation class : 2 Isolierklasse: 2 Aislamiento clase :2 Isolamento classe :2 Isolamento classe :2 Isolatie Klasse : 2 ΚΑΤΗΓΟΡΙΑ ΜΟΝΩΣΗΣ: 2 Izolacja Klazy :2 Eristysluokka :2 Isolering Klass :2 Isoleringsklasse 2 Clasă izolatie :2</p>	<p>Класс изоляции 2 : Yalitim derecesi :2 Třída izolace :2 Izolačný systém 2 Isolasjonsklasse: 2 فئة العزل 2. Szigetelési osztály :2 Razred izolacije :2 Инструмент Клас :2 Isolatsiooniklass 2 Izolācijas rūšis 2 Izolācijas klase 2 Izolacija klasa: 2</p>	X
---	--	--	---

	<p>Usage intérieur uniquement Indoor Use Only Alleen binnenshuis gebruik Sólo uso en interiores Apenas para uso interno Solo uso interno Χρήση σε εσωτερικούς χώρους Tylko do użytku w pomieszczeniach Vain sisäkäyttöön Endast för inomhusbruk Закрит Използвайте само Kun til indendørs brug Utilizare în interior numai</p>	<p>Только для внутреннего использования Kapalı Use Only Vnitřní použití Vnúťorné použitie דבלב ימינפ שרמיש طوق فقول غملا نلنام ال يف مادختسا Csak beltéri használatra Notranja Use Only Kasutamiseks ainult siseruumides Tik naudoti patalpų viduje Lietošanai tikai telpās Nur für Innenräume Samo za unutarnju upotrebu</p>	X
---	--	---	---





	Vitesse à vide :	Скорость вращения на холостом ходу:	3300 min ⁻¹
	No-load speed:	Boşalma hızı:	
	Drehzahl unbelastet:	Rychlost naprázdno:	
	Velocidad vacía:	Rýchlost pri chode naprázdno:	
	Velocità a vuoto:	מהירות ריק.	
	Velocidade no vácuo:	السرعة على الفارغ.	
	Leerlaufdrehzahl:	Üres sebesség:	
	Ταχύτητα αδράνειας:	Prosti tek:	
	Prędkość bez obciążenia:	Скорост на празни обороти:	
	Tyhjäkäyntinopeus	Kiirus tühikäigul	
	Tomgångshastighet:	Tuščio prietaiso greitis	
	Hastighed i ubelastet tilstand:	Tukšgaitas ātrums	
	Viteza în gol:	Brzina praznog hoda:	

	Poids :	Bec :	3,23 kg
	Weight :	Ağırlık :	
	Gewicht :	Hmotnost :	
	Peso :	Hmotnosť :	
	Peso :	משקל	
	Peso :	الوزن.	
	Gewicht :	Súly :	
	Βάρος :	Teža :	
	Masa :	Terno :	
	Paino :	Raskus	
	Vikt :	Svoris	
	Vægt :	Svars	
	Greutate :	Težina:	

		500 N/m
--	--	---------

	Danger :	Опасно :	X
	Danger :	Tehlike :	
	Gefahr :	Nebezpečí :	
	Peligro :	Nebezpečnost :	
	Pericolo :	סכנה.	
	Perigo :	خطر.	
	Gevaar :	Veszély :	
	Κίνδυνος:	Nevarnost:	
	Niebezpieczeństwo :	Опасност :	
	Vaara :	Oht	
	Fara :	Pavojus	
	Fare :	Bistarmība	
	Pericol :	Opasnost:	



	Conformité européenne : Conforms to EC standards : CE-Konformität : Cumples con las directivas CE : Conforme alle norme CE : Conforme às normas CE : Voldoet aan de EG-normen : Ευρωπαϊκή Συμμόρφωση: Zgodność z normami CE : EU-standardien mukainen : EU-standardien mukainen : Overholder EU standarderne : Conform cu normele europene:	соответствие европейским стандартам: Avrupa uygunluk : Evropská shoda : Európska dohoda : התאמה לתקנים האירופיים مطابق للمواصفات الأوروبية. Evropska ustreznost : Európai megfeleléség : Съответствие с европейските норми : Euroopa Liidu vastavusmärk Europinių normų atitikima Atbilstība Eiropas standartiem Euroopska sukladnost	X
--	--	---	---

	Lire les instructions avant usage : Read the instructions before use : Vor Einsatz des Geräts Anweisung lesen : Léase las instrucciones antes de usar : Leggere le istruzioni prima dell'uso : Ler as instruções antes da utilização : Lees voor het gebruik de instructies : Διαβάστε τις οδηγίες πριν από τη χρήση: Zapoznać się instrukcją przed użyciem : Lue ohjeet ennen käyttöä : Läs anvisningarna före användning : læs instruktionerne før brug Înainte de utilizare, cititi instructiunile :	Внимательно прочитайте следующие инструкции : Kullanmadan talimatları okuyunuz : Pozorně si přečtete následující pokyny : Pred použitím si prečítajte pokyny : זרם חילופי اقرأ التعليمات قبل الاستخدام. használat előtt olvassuk el az utasítást : Pred uporabo preberite ustrezna navodila : Прочетете указанията за употреба : Enne kasutamist lugege instruksiooni Prieš naudojimą perskaityti instrukciją izlasīt instrukcijas pirms lietošanas Pročitati upute prije uporabe:	X
--	--	---	---

	Recyclable, soumis au tri sélectif Recyclable, subject to recycling Recyclingfähige, unterliegen Recycling Reciclables, sujetos a reciclaje Riciclabili, soggetti a riciclaggio Recicláveis, sujeitos à reciclagem Recycleerbare, onderworpen aan recycling Ανακυκλώσιμο, υπόκειται σε επιλεκτική διαλογή Opakowanie nadaje się do recyklingu podlegają recyklingu Kierrätettävien pakkausten kohteena kierrätys Återvinningsbara förpackningar omfattas återvinning Рециклираци се опаковки подлежат на рециклиране Genanvendelig underlagt genbrug	Reciclabile sub rezerva reciclare Повторно упаковка подлежит вторичной переработке Geri dönüştürülebilir ambalaj konusuna Recyklovateľné podléhajúci recyklácii Recyklovateľné podliehajúce recyklácii Resirkulerbar, med förbehold om selektiv sortering رويدنلا هاد اعال يفرفرف رويدنلا هاد اعال فليانلا فويلانلا فويلانلا Újrahasznosítható csomagolás alá újrahasznosítás Reciklirati predmet recikliranja Pakendite suhtes ringlussevõtu Pārstrādājams iepakojums otrreizējai pārstrādei Perdīrbamų taikomos perdirbimo Može se reciklirati, podložno selektivnom sortiranju	X
--	--	---	---

	Soumis à recyclage Subjected to recycling Sujeto a reciclaje Sottoposti a riciclaggio Sujeitos à reciclagem Não deite no lixo Niet wegwerpen Υπόκειται σε ανακύκλωση Nie wyrzucac Älä heitä pois luontoon Batteriet får inte kastas Bortkast det ikke Nu le auncati	Подлежит переработке Atmayınız Nevyhazujte je do běžného odpadu Neodhadzovat Gjenvinningspliktig فلا ترمدها لهذا في القمامة. ne mečíte1 Ne odvržite ga/jih vstran Taaskasutusse kuuluv Ärge visake seda minema Nemétykite Nemest Podvrgnuto recikliranju	X
--	---	--	---

Recyclage des déchets :
 Les outils, accessoires et leur emballages doivent suivre une voie de recyclage adaptée. Conformément aux directives Européenne 2012/19/UE et 2006/66/CE, les composants d'un produit doivent être séparés, collectés, recyclés ou éliminés en conformité avec les réglementations environnementales en vigueur. Les appareils, batteries, piles, huiles, emballages devront être déposés dans les systèmes d'élimination des déchets spéciaux tels que déchetteries. Renseignez-vous auprès de votre commune pour connaître l'organisme le plus proche à même de retraiter ou de collecter ces déchets.





	<p>Porter des lunettes de sécurité : Wear protective eyewear : Schutzbrille tragen : Llevar puestas gafas protectoras : Portare de gli occhiali di sicurezza : Utilizar óculos de segurança : Draag een veiligheidsbril : ΦΟΡΑΤΕ ΠΡΟΣΤΑΤΕΥΤΙΚΑ ΓΥΑΛΙΑ: Zakładać okulary ochronne : Käytä suojalaseja : Använd skyddsglasögon : Der skal benyttes sikkerhedsbriller : Purtati ochelari de protecție :</p>	<p>Наденьте защитные очки : Güvenlik gözlükleri takın : Používejte bezpečnostní brýle : Noste ochranné okuliare : Bruk vernebriller : حمل نظارات وقائية. Viseljen védőszemüveget : Nositi zaščitna očala : Да се използват защитни очила : Kandke kaitseprille Nešioti apsauginius akinius Valkät aizsargbrilles Nositi zaštitne naočale:</p>	×
---	--	---	---

	<p>Porter un masque anti-poussière : Wear a dust mask : Staubschutzmaske tragen : Llevar puesta una careta de protección contra el polvo : Indossare una mascherina anti-polvere : Utilizar uma máscara anti-poeira : Draag een stofmasker : ΦΟΡΕΣΤΕ ΜΑΣΚΑ ΓΙΑ ΤΗ ΣΚΟΝΗ: Zakładać maskę przeciwpyłową Käytä pölysuojust : Bär mask mot damm : Der skal benyttes beskyttelsesmaske mod støv: Purtati mască anti-praf :</p>	<p>Наденьте респиратор : Toza karşı maske takın : Používejte masku proti prachu : Noste ochrannú masku proti prachu : Bruk en støvmaske: لبس قناع ع مجراض للذباب. Viseljen povédő maskot Nositi zaščitno masko proti prahu: Да се използва защитна маска : Kandke tolmumaski. Dėvėti respiratorių Valkät aizsarg masku pret puteklēm Nositi masku za zaštitu od prašine:</p>	×
---	---	--	---

	<p>Porter une protection auditive : Wear hearing protective equipment: Gehörschutz tragen: Llevar puesta una protección auditiva: Portare una protezione uditiva: Utilizar uma protecção auditiva: Draag gehoorbeschermers: ΦΟΡΑΤΕ ΠΡΟΣΤΑΣΙΑ ΑΚΟΗΣ: Zakładać słuchawki ochronne Käytä kuulosuojaimia: Bär hörselskydd: Der skal benyttes høreværn: Purtati căști de protecție auz:</p>	<p>наденьте средства звуковой защиты: İşitsel koruma aleti takın: Používejte ochranu sluchu: Noste ochranné slúchadlá: Bruk hørselsvern: لبس خوذة خضض الخسجيح Viseljen fülvédőt Nositi zašito ušes: Да се използва слухови защитни средства: Kandke kõrvakaitset Nešioti apsaugą nuo triukšmo Valkät dzirdes aizsargīdzekļi Nositi šitnikie protiv buke:</p>	×
--	--	--	---

	<p>Porter des gants : Use rubber gloves : Schutzhandschuhe tragen : Llevar guantes de protección : Indossare i guanti di protezione : Utilizar luvas de protecção : Draag veiligheidshandschoenen : ΦΟΡΩΝΤΑΣ ΓΑΝΤΙΑ: Używać rękawic ochronnych : Käytä suojakäsineitä : Använd skyddshandskar : Der skal benyttes handsker : Purtati mănuși :</p>	<p>Наденьте перчатки : Eldiven takın : Noste rukavice : Noste rukavice : Bruk hansker: لبس قفازات. Viseljen kesztyű t Nositi rokavice: а се използват предпазни ръкавици : Kandke kindaid Müvėti pirštines Valkät cimdus Nositi zaštitne rukavice:</p>	×
---	---	--	---





 L_{pA}	Niveau de pression acoustique :	Уровень акустического давления. :	93 dB (A)
	Acoustic pressure level :	Akustik basınç seviyesi :	
	Schalldruckpegel :	Hladina akustického tlaku :	
	Nível de presión acústica :	Hladina akustického tlaku :	
	Livello di pressione acustica :	רמת לחץ אקוסטי.	
	Nível de pressão acústica :	مستوى الضغط السمعي.	
	Niveau akoestische druk :	A hangnyomás szintje :	
	Στάθμη ηχητικής πίεσης:	Nivo akustičnega pritiska:	
	Poziom mocy akustycznej :	Равнище на акустично налягане :	
	Käytä kuulosuojaimia :	Helirõhu nivoo	
Ljudtrycksnivå :	Akustinio spaudimo lygis		
Lydtryk :	Akustiská spedična límenis		
Nível presiune acustică :	Razina zvučnog tlaka:		

 L_{wA}	Niveau de puissance acoustique :	уровень мощности звука :	104 dB (A)
	Acoustic power level :	Akustik basınç seviyesi :	
	Schalleistungspegel :	Hladina zvukového výkonu:	
	Nível de potencia acústica :	Hladina zvukového výkonu:	
	Livello di potenza acustica:	רמת כוח אקוסטי.	
	Nível de potência acústica:	مستوى الصوتي.	
	Niveau akoestisch vermogen :	a hangnyomás szintje :	
	Επίπεδο ισχύος ήχου:	Nivo akustične jakosti :	
	Poziom mocy akustycznej :	Равнище на вибрации :	
	Käytä suojalaseja :	Helivõimsuse nivoo	
Ljudstyrkenivå :	Triukšmo lygis		
Lydstyrke :	Akustiskās jaudas līmenis		
Nível putere acustică :	Razina zvučne snage:		

NIVEAU SONORE D'ÉMISSION : A VIDE

Pression acoustique L_{pA} poste opérateur 93 dB
Incertitude 3

Puissance acoustique L_{wA} 104 dB
Incertitude 3

Valeurs déterminées suivant le code d'essai de l'annexe B de la norme EN 61029-1 avec emploi des normes de base ISO 11201 et ISO 3744.

Les niveaux de pression acoustique obtenus in situ dépendent :

- Des niveaux réels de la machine considérées, en prenant en compte les incertitudes déclarées;
- Du local et de l'installation de la machine. Préférez une pièce dont l'acoustique est plus feutrée.

Évitez les pièces vide à grande résonance. Placez vous auprès d'une fenêtre le cas échéant.

- Des outils montés, des pièces travaillées, des réglages choisis,...

 L_v	Niveau de vibration :	Уровень вибрации :	10,65 m / s ²
	Hand/arm vibration level :	Titreşim seviyesi :	
	Vibrationspegel Hand/Arm :	Úroveň vibrací :	
	Nível de vibración mano/brazo :	Hladina vibrácií :	
	Livello di vibrazione mano/braccio :	רמת תנודות	
	Nível de vibração mão/braço :	مستوى الارتجاج.	
	Trillingsniveau hand/arm :	Vibrációszint :	
	Επίπεδο κραδασμών:	Nivo vibracij :	
	Poziom wibracji rżka/ramię :	Равнище :	
	Tärinätaso:	Vibrācijas līmenis.	
Vibrationsnivå hand/arm :	Vibrācijas lygis		
Vibrations niveau :	Vibratsiooninivo		
Nível vibrații :	Razina vibracije:		

VIBRATIONS:

Total des valeurs de vibration (somme vectorielle des trois directions) déterminée selon EN 60745 :

a 10,65 m/s²
Incertitude K 1,5 m/s²

L'amplitude d'oscillation peut être utilisée comme valeur de comparaison d'outils électroportatifs.

Attention : si l'outil électroportatif est utilisé pour d'autres applications, avec d'autres outils de travail, l'amplitude d'oscillation peut être différente.





CH 500

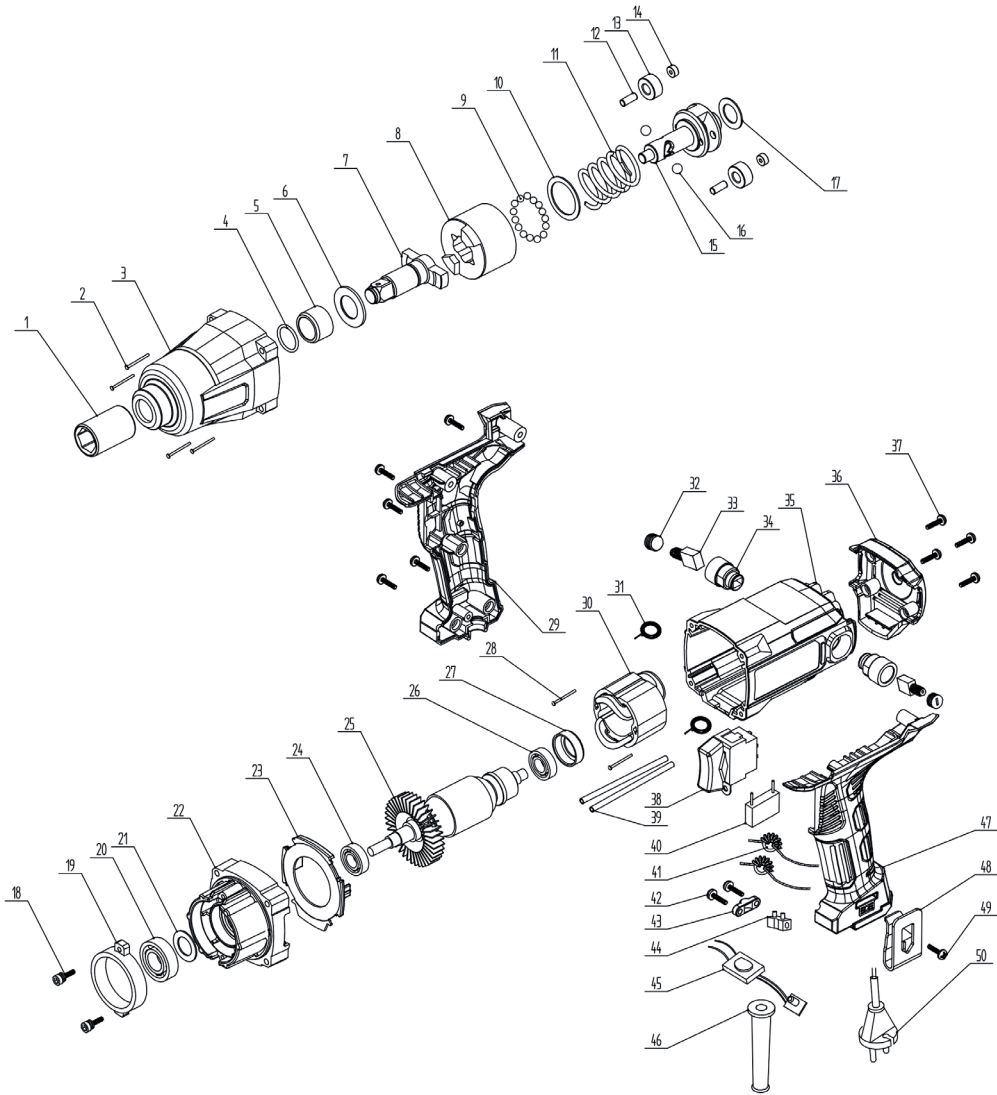



DECLARATION DE CONFORMITE
 VERKLARING VAN OVEREENSTEMMING
 DECLARACION DE CONFORMIDAD
 DICHIARAZIONE DI CONFORMITA
 KONFORMITÄSERKLÄRUNG
 DECLARATION CONFORMITY
 DECLARAÇÃO DE CONFORMIDADE
 DEKLARÁCIA ZGODNOSCI Z NORMAMI
 OM ÖVERENSSTÄMMELE
 VAATIMUSTENMUKAISUUSVAKUUTUS
 ÖVERENSSTEMMELSESERKLÄRING
 ΔΗΛΩΣΗ ΣΥΜΜΟΡΦΩΣΗΣ
 DECLARAȚIE DE CONFORMITATE

VYHLÁSENIE ZHODY
 Декларация соответствия
 הצהרת תואמת
 Uygunluk beyanı
 التصريح بالامتثال
 PRÓHLÁŠENÍ SHODY
 EGYZESÉGI NYILATKOZAT
 Декларация за съответствие с нормите
 IZJAVA O SKLADNOSTI
 DEKLARACIJA
 ATITIKTIES DEKLARACIJA
 KINNITUS
 IZJAVA O SUKLADNOSTI

Le soussigné,
 Ondergetekende,
 Der Unterzeichner,
 O abaixo assinado,
 Undertecknad,
 Долуподписаният
 Undertegnede
 Subsemnatul,
 Ο κάτωθι υπογεγραμμένος,
 Imzalayan,
 Niže podepsany,
 Toliau pasirašęs
 El suscrito,

Déclare par la présente que,
 Verklaart hiermede dat,
 Erklärt hiermit daß,
 Declara pela presente que,
 Förklarar härmed att
 Заявява с настоящото
 erklærer hermed, at
 Declar prin prezenta că,
 Με το παρόν δηλώνει ότι,
 Mecvut belgeyle beyan ediliyor ki,
 tímto prohlašuje, že,
 Pareiškia, kad,
 Declara por la presente, que,

Personne autorisée à constituer
 le dossier technique :
 Ronan GUILLIOT



FAR GROUP EUROPE
 192, Avenue Yves Farge
 37700 St. Pierre-des-Corps
 FRANCE

Il sottoscritto,
 The undersigned,
 Niņeļ podpisany
 Allekirjoittanut,
 Öyttögramm9enož
 Nižšie podpisany
 ההתחם מט
 الحقوق وأنا
 Alulfrött,
 Podpisani,
 Apakšā parakstījis
 allakirjutanu
 Dolje potpisani,

Dichiari che,
 Declares that,
 OÖwiadczam niniejszym, że
 Ilmoitetaan täten että,
 Dhl9vnei me thn Paro9yssa
 tímto vyhlasuje, že
 מצהיר בזה כי
 يصرح استنادا على ذلك
 kijelentem, hogy a készülék izjavlja da,
 Pareiškia, kad,
 Ar šo apliecinā, ka,
 Kinnitab, et
 izjavljuje u ovom dokumentu da je

Visseuse à choc / Impact wrench / Schlagschrauber / Atornillador de impacto / Avvitatrice ad urti / Aparafusadora de percussão / Slagschroevendraaier / Κρουστική μηχανή βιδώματος / Wkretarka udarowa / Iskuruuvaava porakone / Slagskrudragare / машина за завинтване с удар / Stodskruemaskine / Mašinā de iņšurubat electro-pneumaticā / ударний шурупверт / Soklu vidalayıcı / Nárarová uzavíračka / Nárarový uzatvárač / סימלה הרבם / قیاطیل راشنم / Elektropneumatikus csavarozó / Udarni vijačnik / Löökjõuga kruvikeeraja / Elektriskais skrūvgriezis / Smūginis tvirtinimo aparatas / Otvijač za bežični šok

code

FARTOOLS / 115005 / CH 500 / P1B-DD20-12

Est conforme et satisfait aux directives et normes CE,
 In overeenstemming is met en Voldoet aan EG richtlijnen,
 Den folgenden EU-Bestimmungen entspricht,
 Respeita e está em conformidade com as normas CE,
 Överensstämmer med och uppfyller EG-standarder,
 Съответства и отговаря европейските норми
 Er i overensstemmelse med og overholder EU standarderne
 Este conform și satisface normele CE
 полностью соответствует и удовлетворяет требованиям стандартов ЕС
 CE şartlara uygundur,
 odpovídá normám ES.
 Atitinka ir atitinka EB direktyvas ir standartus,
 Cumples con la directivas de la CE,

È conforme alle direttive CEE,
 Complies with the EEC directives and standards,
 Odpowiada normom UE,
 Täyttää EU-vaatimukset,
 Συμμορφώνεται και πληροί τις οδηγίες και τα πρότυπα CE,
 zodpovedá normám ES.
 מתאים ועונה לתקני CE
 بأن الوجود ي تطابق و يلبى مع مجموعة الدول الأوروبية
 kielgēti a CE szabványok előírásait.
 Je v skladu z in izpolnjuje norme Evropske skupnosti.
 Atbilst un atbilst EK direktyvas un standartus,
 Vastab ja vastab EU direktīvi dele ja standartiteile,
 Sukladan i ispunjava direktive i standarde CE,

2006/42/EC 2014/30/EU 2011/65/EU&2015/863/EU

EN 62841-1:2015+AC:15
 EN 62841-2-2:2014+AC:2015

EN IEC 55014-1:2021
 EN IEC 55014-2:2021
 EN IEC 61000-3-2:2019+A1:2021
 EN 61000-3-3:2013+A1:2019+A2:2021

Ronan GUILLIOT,
 Directeur général
 12/12/2022
 Fait à St. Pierre-des-Corps

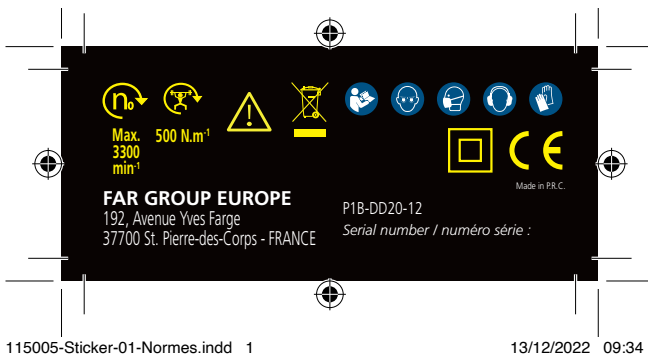

GARANTIE - WARRANTY



FR. GARANTIE

Cet outil est garanti contractuellement contre tout vice de construction et de matière, à compter de la date de vente à l'utilisateur et sur simple présentation du ticket de caisse. La garantie consiste à remplacer les parties défectueuses. Cette garantie n'est pas applicable en cas d'exploitation non conforme aux normes de l'appareil, ni en cas de dommages causés par des interventions non autorisées ou par négligence de la part de l'acheteur. La garantie ne s'applique pas sur les dommages causés par une défaillance de l'outil.

DE. GARANTIE

Die Garantiezeit für dieses Gerät in Bezug auf Konstruktions- und Materialfehler beträgt 1. Vertrag bei Vorlage des Kassensbons. Die Garantieleistung besteht im Ersatz schadhafter Teile. Die Garantie erlischt bei einem Einsatz des Geräts, der nicht normentsprechend ist, bei Schäden, die auf unsachgemäße Eingriffe zurückzuführen sind bzw. bei Nachlässigkeit seitens des Käufers. Die Garantie erstreckt sich nicht auf Schäden, die auf Fehlfunktionen des Geräts zurückzuführen sind.

IT. GARANZIA

Quest' attrezzo è garantito per contratto contro qualsiasi difetto di costruzione e di materia, a partire dalla data di vendita all'utente e su semplice presentazione dello scontrino. La garanzia consiste nel sostituire le parti difettose. Questa garanzia non è applicabile in caso di sfruttamento non conforme alle norme dell'apparecchio, né in caso di danni causati da interventi non autorizzati o da negligenza da parte dell'acquirente. La garanzia non si applica ai danni causati da un'avarità dell'attrezzo.

EN. GARANTEE

This tool is guaranteed, in writing, against any defect in manufacture of parts from the date of sale, upon simple presentation of the sales slip. The guarantee is limited to the replacement of faulty parts. This guarantee is not applicable in the event of usage which is not conform with the intended usage of the apparatus, nor in the event of damage caused by unauthorised servicing or negligence on behalf of the purchaser. This guarantee does not apply to any damage caused by

the failure of this tool.

ES. GARANTIA

Esta herramienta se garantiza contractualmente contra todo defecto de construcción y materia, a partir de la fecha de venta a l' usuario y sobre simple presentación del recibo de caja. La garantía consiste en sustituir a las partes defectuosas. Esta garantía no es aplicable en caso de explotación no conforme a las normas del aparato, ni en caso de daños causados por intervenciones no autorizadas o por negligencia por parte del comprador. La garantía no se aplica sobre los daños causados por un fallo del herramienta.

NL. GARANTIE

Dit gereedschap heeft een garantie tegen constructiefouten en materiaaldefecten, die geldig is vanaf de aankoopdatum door de gebruiker, op vertoning van de kassabon. De garantie betreft de vervanging van de defecte onderdelen. Deze garantie is niet van toepassing indien het apparaat niet volgens de normen gebruikt is, noch in geval van schade veroorzaakt door onjuist gebruik of nalatigheid van de koper. De garantie is niet van toepassing op schade voortvloeiend uit een defect van het gereedschap.

PT. GARANTIA

Esta ferramenta tem uma garantia contratual contra qualquer defeito de construção e de material, a partir da data de venda ao utilizador e sobre simples apresentação do talão da caixa. A garantia consiste em substituir as partes defeituosas. Esta garantia não é aplicável no caso de exploração não conforme as normas do aparelho, nem em caso de danos causados pelas intervenções não autorizadas ou por negligência da parte do comprador. A garantia não se aplica para os danos causados por uma falha da ferramenta.

EL. ΕΓΓΥΗΣΗ

ΑΥΤΟ ΤΟ ΕΡΓΑΛΕΙΟ ΕΙΝΑΙ ΣΥΜΒΑΤΙΚΑ ΕΓΓΥΗΜΕΝΟ ΓΙΑ ΟΠΟΙΟΔΗΠΟΤΕ ΚΑΤΑΣΚΕΥΑΣΤΙΚΟ ΚΑΙ ΥΛΙΚΟ ΕΛΑΤΤΩΜΑ, ΑΠΟ ΤΗΝ ΗΜΕΡΟΜΗΝΙΑ ΠΩΛΗΣΗΣ ΣΤΟΝ ΧΡΗΣΤΗ ΚΑΙ ΜΕ ΤΗΝ ΕΠΙΔΕΙΞΗ ΤΗΣ ΑΠΟΔΕΙΞΗΣ ΠΩΛΗΣΗΣ. Η ΕΓΓΥΗΣΗ ΣΥΝΙΣΤΑΤΑΙ ΣΤΗΝ ΑΝΤΙΚΑΤΑΣΤΑΣΗ ΤΩΝ ΕΛΑΤΤΩΜΑΤΙΚΩΝ ΕΞΑΡΤΗΜΑΤΩΝ. ΑΥΤΗ Η ΕΓΓΥΗΣΗ ΔΕΝ ΙΣΧΥΕΙ ΣΕ ΠΕΡΙΠΤΩΣΗ ΛΕΙΤΟΥΡΓΙΑΣ ΠΟΥ ΔΕΝ ΣΥΜΜΟΡΦΩΝΕΤΑΙ ΜΕ ΤΑ ΠΡΟΤΥΠΑ ΤΗΣ ΣΥΣΚΕΥΗΣ, ΟΥΤΕ ΣΕ ΠΕΡΙΠΤΩΣΗ ΖΗΜΙΑΣ ΠΟΥ ΠΡΟΚΑΛΕΙΤΑΙ ΑΠΟ ΜΗ ΕΞΟΥΣΙΟΔΟΤΗΜΕΝΕΣ ΕΠΕΜΒΑΣΕΙΣ Ή ΑΜΕΛΕΙΑ ΕΚ ΜΕΡΟΥΣ ΤΟΥ ΑΓΟΡΑΣΤΗ. Η ΕΓΓΥΗΣΗ ΔΕΝ ΙΣΧΥΕΙ ΓΙΑ ΖΗΜΙΕΣ ΠΟΥ ΠΡΟΚΑΛΟΥΝΤΑΙ ΑΠΟ ΑΣΤΟΧΙΑ ΕΡΓΑΛΕΙΟΥ.

PL. GWARANCJA

Narz dzie jest obj te gwaranc-

jà na wszelkie wady konstrukcyjne i materiałowe, licząc od daty sprzedaży u użytkownika i po okazaniu paragonu kasowego. Gwarancja obejmuje wymianę części wybrakowanych. Gwarancja nie znajduje zastosowania w przypadku u użytkownika niezgodnego z normami urządzenia, ani w przypadku szkód spowodowanych działaniami nieodzwolonymi lub zaniedbaniami ze strony nabywcy. Gwarancja nie obejmuje szkód powstałych z powodu upadku urządzenia.

SV. GARANTI

Detta verktyg har en avtalsenlig garanti mot konstruktions- och materialfel, från och med tidpunkten för användarens inköp och genom uppvisning av kassakvittot. Garantin består i att ersätta de bristfälliga delarna. Denna garanti gäller inte om användningen inte motsvarar apparatens standarder, inte heller vid skador som orsakas av ej tillåtna ingrepp eller på grund av koparens vårdslöshet. Garantin gäller inte förskador som orsakats av att verktyget fungerat bristfälligt.

FI. TAKUU

Tämän laitteen takuu on voimassa sopimusmenukaisesta kattaen kaikki rakenne- ja materiaaliuivat lukien ostopäivästä kassakuitilla vastaan. Takuu sisältää viallisten osien korvaamisen. Takuu ei korvaa ohjeidenvastaista käyttöä eikä valtuuttamattomien henkilöiden käsittelyä tai ostajan huolimattomuudesta aiheutuneita vahinkoja. Takuu ei vastaa myöskään toimintavälineistä aiheutuneita vahinkoja.

BU. Гаранция

Този инструмент е под договорна гаранция срещу всякакъв дефект в изработката и използваните материали, считано от датата на продажба на потребителя и само срещу представяне на касовата бележка. Гаранционното обслужване се състои в замяна на дефектните части. Настоящата гаранция не е валидна когато апаратът се използва по начин, несъответстващ на стандарта за работа с него, както и в случай на щети, нанесени от неоторизирани лица, или вследствие на проявена небрежност от страна на потребителя. Гаранцията не покрива щети, произтекли вследствие на техническа неизправност на апарата.

DA. GARANTI

Dette værktøj er dækket af en garantikontrakt for konstruktions- og materialefej, som gælder fra købsdatoen ved visning af kassebonen. Garantien består i at udskifte de defekte dele. Garantien dækker ikke fejl opstået som følge af anvendelse, som ikke overholder

SERVICE APRÈS VENTE - AFTER SALE SERVICE

FARGROUP EUROPE - 192, Avenue Yves Farge - 37700 St. Pierre-des-Corps - FRANCE

fargroup@fargroup.net

GARANTIE - WARRANTY



standarderne for apparatet, eller skader opstået ved ikke autoriserede indgreb eller sløsethed fra brugerens side. Garantien dækker ikke skader opstået, fordi værktøjet har svigtet.

RO. GARANTIE

Acest aparat este garantat din punct de vedere contractual împotriva tuturor viciilor de construcție și de material, începând de la data vânzării lui către utilizator și la simpla prezentare a bonului de casă. Garanția constă în înlocuirea componentelor defecte. Această garanție nu se aplică în cazul exploatarei în alt mod decât cel recomandat de norme de aparatură și nici în caz de stricăciuni provocate de intervenții neautorizate sau prin neglijența cumpărătorului. Garanția nu se aplică asupra pagubelor cauzate de o defectare a aparatului.

RU. ГАРАНТИЯ

Данное изделие обладает именной силой контракта и силой гарантии, покрывающей все возможные дефекты изготовления и материала. Гарантия вступает в силу с даты продажи изделия пользователю, для этого достаточно сохранить и предъявить полученный в кассе чек. Гарантия обязывает изготовителя заменить дефектные части изделия. В случае не соответствующего нормам использования изделия, несанкционированного демонтажа или ремонта или небрежного обращения действие гарантии прекращается. Гарантия не покрывает ущерб, возникшего в результате сбоя в работе изделия.

HU. GARANTIA

Bu áracs, satts tarihinden itibaren, kullanicinin sádece vezne alindisini sunmasiyla tum uretim ve malzeme hatasina karsi garantilidir. Garanti eksik olan kisimlari degistirmek icindir. Bu garanti aracin sartlarina uymun olmayan isleme durumunda, izgin verilmeyen kullanimlardan kaynaklanan hasarlarda veya alincin istegi durumunda uygulanmaz. Garanti malzemenin bir eksikliginden meydana gelen bir zararda uygulanmaz.

CS. ZÁRUKA

Pro tento nástroj platí smluvní záruka na všechny výrobní a materiálové vady od data prodeje uživateli a na základě předložení pokladničního bloku. Záruka spočívá ve výměně vadných částí. Tato záruka neplatí v případě použití přístroje, které

neodpovídá normám, ani v případě škod způsobených nepovolenými zásahy nebo nedbalostí ze strany kupujícího. Záruka se nevztahuje na škody způsobené závadou nástroje.

SK. ZÁRUKA

Pre tento nástroj platí zmluvná záruka na všetky výrobné a materiálové chyby od dátumu predaja užívateľovi a na základe predloženia pokladničného bloku. Záruka spočíva vo výmene chýbných častí. Táto záruka neplatí v prípade použitia prístroja, ktoré nezodpovedá normám, ani v prípade škod spôsobených nepovolenými zásahmi alebo nedbalosťou zo strany kupujúceho. Záruka sa nevzťahuje na škody spôsobené poruchou nástroja

AR. الضمان

على مجرد تقديم بطاقة الشراء يتعلم من تاريخ البيع الذي إلى المشتري وبيناء عيب فني التصدي عوفى الجوانب. اعتباراً من هذه الألة مدة مضمونة تعاقدياً من أي الجهاز، ولا في حالة تعرضه لتدخلات غير الحالة الاستخدام غير المطابق لمعايير لا يكون هذا الضمان قابلاً للتطبيق في حالة الخرجان فني استبدال الأجزاء الأعطال لا يطبق الضمان على الخرجان الناتج عن مخرجة أو فني حالة الجهاز من قبل المشتري. راتجة عن عمليات تدخل غير

HU. GARANCIA

Erre a szerszámra szerződéses garanciát vállalunk bármilyen gyártási és anyaghiba felmerülése esetére, a fogvaszto részere tortent eladás napjától számítva, a penztári blokk egyszerű felmutatása ellenében. A garancia a hibás alkatrészek cseréjére terjed ki. Ez a garancia nem érvényes, ha a készüleket nem rendeltetésszerűen használták, sem illetéktelen beavatkozások, vagy a vásárló hanyagsága okozta károk esetén. A garancia nem fedezi azokat a károkat, melyeket a szerszám hibás működése okozott.

SI. GARANCIJA

To orodje je z garancijsko pogodbo zasciteno proti vsem napakam v izdelavi in v sestavnem materialu od datuma prodaje naprej in ta velja ob predložitvi blagajniškega računa. Garancija velja za zamenjavo delov z napako. Ta garancija ne velja za uporabo orodja, ki ni v skladu z normami, predpisanimi za omenjeno orodje in za primere okvar, ki nastanejo zaradi nedovoljenih posegov na orodju ali zaradi malomarnega rokovanja kupca. Garancija ne velja za škodo, ki jo lahko povzroci okvara orodja.

ET. GARANTII

See toorist kuulub lepingu järgi garantiiremonti arvestades alates müümise päevast ja kassatseki alusel kasutajale koigi konstruktsiooni- ja materjalivigade puhul. Garantii seisneb defektsete osade valja-

vahetamises. See garantii ei kehti aparaadi normide ebatavalise eiramise puhul ega ostja poolt keelatud viisil kasutamistest või hooletusetahtmisest tulenevate kahjude korral. Garantii ei kehti seadme defektidest põhjustatud kahjude puhul

IV. GARANTIIJA

Sis prietaisas yra užtikrinamas kaip itin geros kokybes, nuo jo pardavimo datos iki jo panaudojimo, ir jam yra suteikiamas garantinis talonas. Garantijos metu galima pakeisti atsiradusius trumplaikius gedimus. Si garantija netaikoma esant netinkamam naudojimui ar nesilaikant reikiam sio aparato vartojimo instrukcijai, tai pat paciam virkelei ji sugadinus. Garantija taip pat netaikoma, prietaisa naudojant ne pagal paskirti ir ji apgadinus

LT. GARANTIJA

Sim darbanikam ir liguma noteikta garantija visiem defektiem, kas saistās ar konstrukciju un materiālu, sakot ar pardanas datumu, kad mašīnu pardot lietotājam un vienkarsi uzradot kases ceku. Garantija iekļauj bojāto daļu nomaiņu. Si garantija nav derīga, ja aparāts nav lietots saskaņā ar drošības noteikumiem, ne gadijums, ja bojājumi radusies nesankcionētas ielauksanas gadijuma vai arī pierceja holaidības del. Garantija nav derīga, ja bojājumi radusies darbanika defekta del

HR. JAMSTVO

Ovaj alat ima ugovorno jamstvo u slucaju bilo kakvih nedostataka u konstrukciji i materijalu, od datuma prodaje korisniku uz jednostavno predocenje racuna. Jamstvo se sastoji u zamjeni neispravnih dijelova. Ovo se jamstvo ne primjenjuje u slucaju uporabe i eksploatacije koja nije sukladna standardima uređaja, niti u slucaju stete uzrokovane neovlastenim intervencijama ili nemarom kupca. Jamstvo se ne primjenjuje na štetu uzrokovanu nekim nedostatkom alata.

SERVICE APRÈS VENTE - AFTER SALE SERVICE

FARGROUP EUROPE - 192, Avenue Yves Farge - 37700 St. Pierre-des-Corps - FRANCE

fargroup@fargroup.net



FAR GROUP EUROPE

Une société du groupe **SIGMA**

192, Avenue Yves Farge
37700 St. Pierre-des-Corps
FRANCE

fartools.com

