

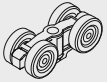

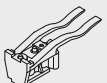









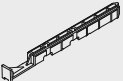
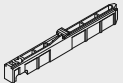
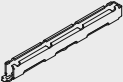

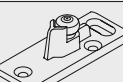

**Garniture pour montage au plafond,
pour 1 porte en bois jusqu'à 100 kg**

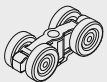
	N°.
Hawa Porta 100 HMT, Pocket hauteur d'installation minimal, pour 1 porte	057.3133.073

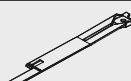
Garniture composée de :		057.3133.073	N°.
	Chariot, roulement à billes, galets plastique blanc	2	057.3114.071
	Butée, avec ressort de blocage, plastique, gris	2	057.3073.072
	Vis à tête hexagonale, M8x36 mm, acier, zingué	1	042.0165.101
	Vis à tête cylindrique, M8x35 mm, acier, zingué	1	042.0175.001
	Cache, plastique, gris	1	600.0000.533
	Support de roulement, plastique, anthracite	1	042.0167.001
	Support de roulement, plastique, anthracite	1	042.0174.001
	Boîtier, acier, zingué	1	042.0166.101
	Boîtier, acier, zingué	1	042.0166.102
	Vis à tête fraisée, 4x40 mm, acier, zingué	8	766.5040.140
	Guidage au sol, avec chariot, réglable, plastique, anthracite	1	057.3120.071
	Vis à tête fraisée, 4x20 mm, acier, zingué	4	766.5042.120



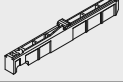
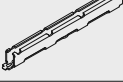



**Kit pour montage au plafond,
pour 1 porte en bois jusqu'à 100 kg**

	N°.
Hawa Porta 100 HMT Pocket, avec Push-to-open, avec rail de roulement, 2000 mm, aluminium, anodisé, pour 1 porte	057.3181.072





Garniture composée de :		mm	057.3181.072	N°.
	Chariot, roulement à billes, galets plastique blanc		2	057.3114.071
	Butée, sans ressort de blocage, plastique, gris		2	057.3073.071
	Amortissement, roulement en haut, 61–100 kg, plastique		1	042.3106.071
	Déclencheur pour amortissement dans le bâtiment, zinck moulé sous pression		1	042.3105.001
	Push-to-open Hawa Porta 100, 40–100 kg, avec retour automatique		1	057.3177.071
	Pièce de déclenchement pour Push-to-open, zinck moulé sous pression		1	057.3176.001
	Set à vis amortissement		2	600.0000.566
	Vis à tête hexagonale, M8x36 mm, acier, zingué		1	042.0165.101
	Vis à tête cylindrique, M8x35 mm, acier, zingué		1	042.0175.001
	Cache, plastique, gris		1	600.0000.533
	Support de roulement, plastique, anthracite		1	042.0167.001
	Support de roulement, plastique, anthracite		1	042.0174.001
	Boîtier, acier, zingué		1	042.0166.101
	Boîtier, acier, zingué		1	042.0166.102

Suite du tableau page suivante

Tableau suite de la page précédente

	Vis à tête fraisée, 4x40 mm, acier, zingué	8	766.5040.140	
	Guidage au sol, avec chariot, réglable, plastique, anthracite	1	057.3120.071	
	Vis à tête fraisée, 4x20 mm, acier, zingué	4	766.5042.120	
	Rail de roulement, aluminium, anodisé, percé	2'000	1	057.3174.200
	Bouton de montage, plastique, gris	9	057.0201.001	
	Vis à tête fraisée, 5x40 mm, acier, zingué	10	766.3054.140	

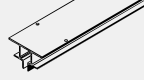



Rails de roulement

		mm	N°.
	Rail de roulement, aluminium, perforé	1'700	057.3016.170
		2'000	057.3016.200
		2'500	057.3016.250
		6'000	057.3016.600
		sur mesure	057.3016.990
	Rail de roulement, aluminium, anodisé, perforé	2'000	057.3016.201
		2'500	057.3016.251
		6'000	057.3016.601
		sur mesure	057.3016.991
	Rail de roulement, avec ouverture de montage, aluminium, anodisé, percé	2'500	057.3016.256
		sur mesure	057.3016.998
	Rail de roulement, intégration au plafond, aluminium, anodisé, percé	2'500	27668
		3'500	27667
		6'000	30326
		sur mesure	27669
	Recouvrement des rails pour rail de roulement Hawa Porta 45/60/100, plastique, black	2'000	057.3098.001
		sur mesure	057.3098.990

Set de montage

		N°.
Kit de montage Hawa Porta 60/100, 2000 mm		057.3179.200
Kit de montage Hawa Porta 60/100, 2500 mm		057.3179.250



Garniture composée de :

		mm	057.3179.200	057.3179.250	N°.
	Rail de roulement, aluminium, anodisé, percé	2'000	1		057.3174.200
	Bouton de montage, plastique, gris		9	11	057.0201.001
	Vis à tête fraisée, 5x40 mm, acier, zingué		10	12	766.3054.140
	Rail de roulement, aluminium, anodisé, percé	2'500		1	057.3174.250

Amortissement

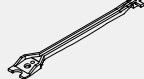

Pour amortissement dans le sens d'ouverture et de fermeture veuillez commander 2 garnitures.

		N°.
Amortissement Hawa Porta 100, Divido 100, 61-100 kg, 1 pièce		042.3102.071
Amortissement Hawa Porta 60/100, Divido 100, 10-60 kg, 1 pièce		042.3102.072

		042.3102.071	042.3102.072	N°.
	Amortissement, roulement en haut, 61-100 kg, plastique	1		042.3106.071
	Déclencheur pour amortissement dans le bâtiment, zinck moulé sous pression	1	1	042.3105.001
	Set à vis amortissement	1	1	600.0000.566
	Amortissement, roulement en haut, 10-60 kg, plastique		1	042.3106.072

Push-to-open avec fermeture automatique par traction (ne doit être utilisé qu'avec Hawa Porta 100)

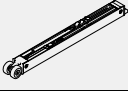
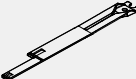
	N°.
Push-to-open Hawa Porta 100, 40-100 kg, 1 pièce	057.3178.071

Garniture composée de :		057.3178.071	N°.
	Push-to-open Hawa Porta 100, 40-100 kg, avec retour automatique	1	057.3177.071
	Pièce de déclenchement pour Push-to-open, zinck moulé sous pression	1	057.3176.001
	Set à vis amortissement	1	600.0000.566



Cache ouverture de montage

	N°.
Cache pour ouverture de montage, kit de 1 pièce	042.3114.071

Garniture composée de :		042.3114.071	N°.
	Cache ouverture de montage, plastique, gris	1	042.0172.001
	Set à vis amortissement	1	600.0000.566

Jeu de vis



	N°.
Kit de vis pour intégration au plafond, +15 mm	057.3180.071

Garniture composée de :		057.3180.071	N°.
	Vis à tête hexagonale, M8x51 mm, acier, zingué	2	042.0165.103
	Vis à tête cylindrique, M8x50 mm, acier, zingué	1	042.0175.002

Jeu de guidage de fond inférieur pour montage mural

	N°.
 Set guidage au sol pour montage murale, avec chariot	057.3128.171

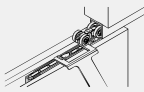
Accessoires

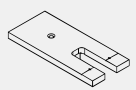
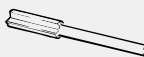
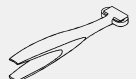
	N°.
 Clé de démontage, acier, zingué	042.3119.101
 Butée à ressort Hawa Porta 60/100	27760
 Gabarit de fraisage pour ouverture de montage	042.3118.071
 Fraise à rainurer pour gabarit de fraisage, Ø= 10 mm, métal dur	600.0000.309
 Nettoyant pour rails, plastique, bleu	057.3099.071

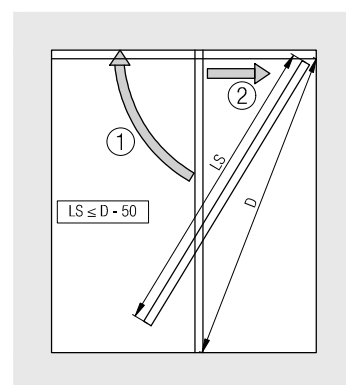
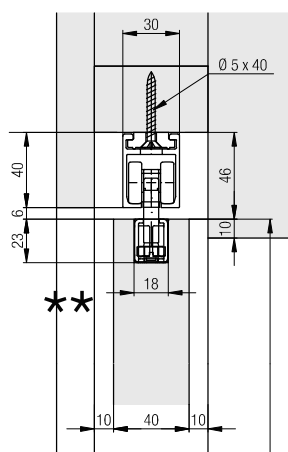
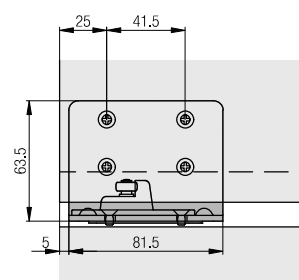
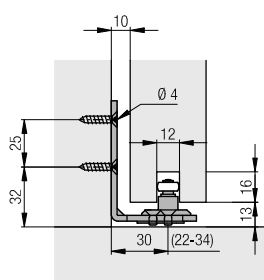
Kit de montage/montage des rails Pocket

Montage mural guidage de fond inférieur

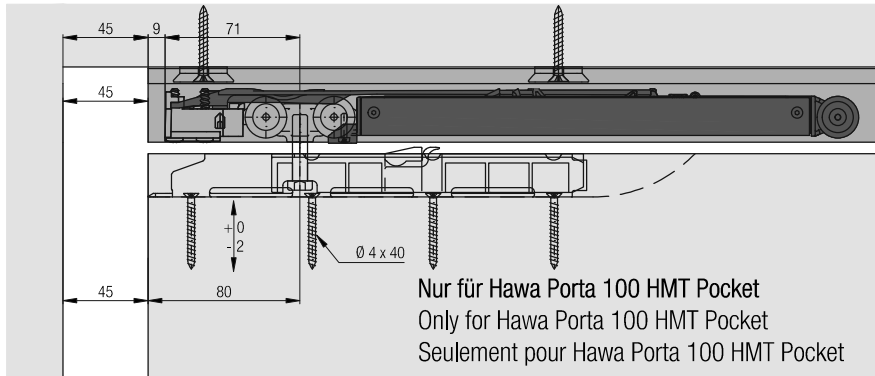
Push-to-open avec fermeture automatique par traction



Türgewicht / door weight / poids de la porte 40-100 kg

Intégration au plafond

Recommandation : Pour les systèmes intégrés au plafond, permettre une ouverture de montage ou un accès par l'avant à la technique.

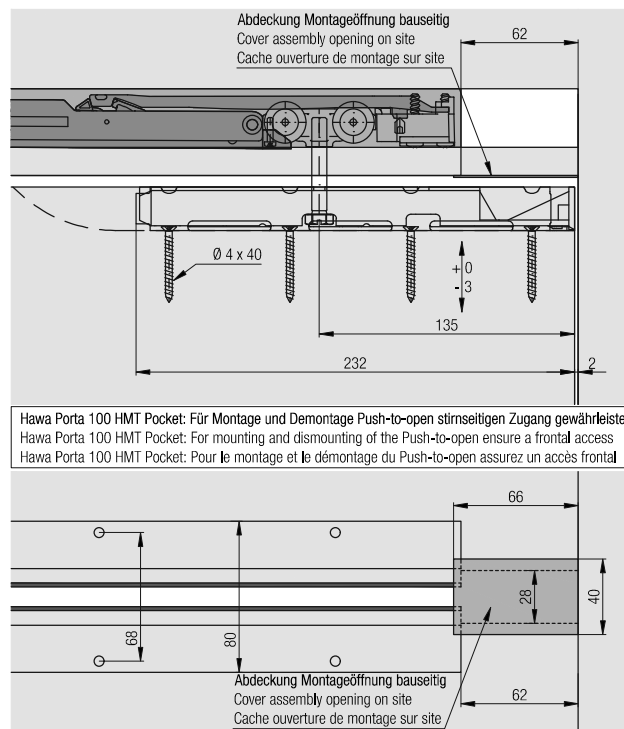
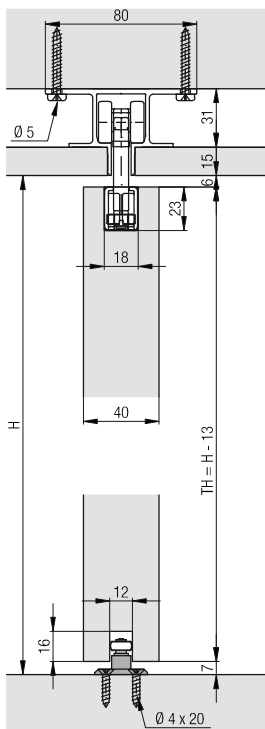

Butée à ressort

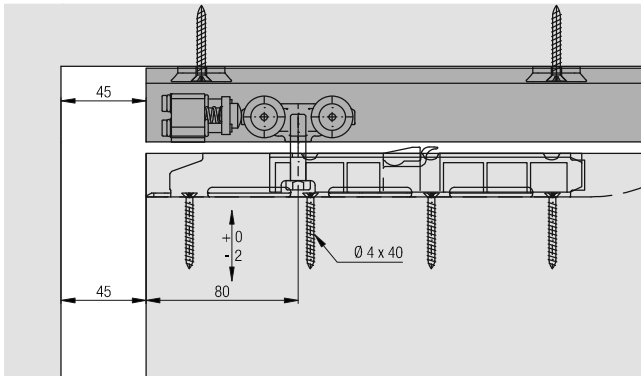

Calculs

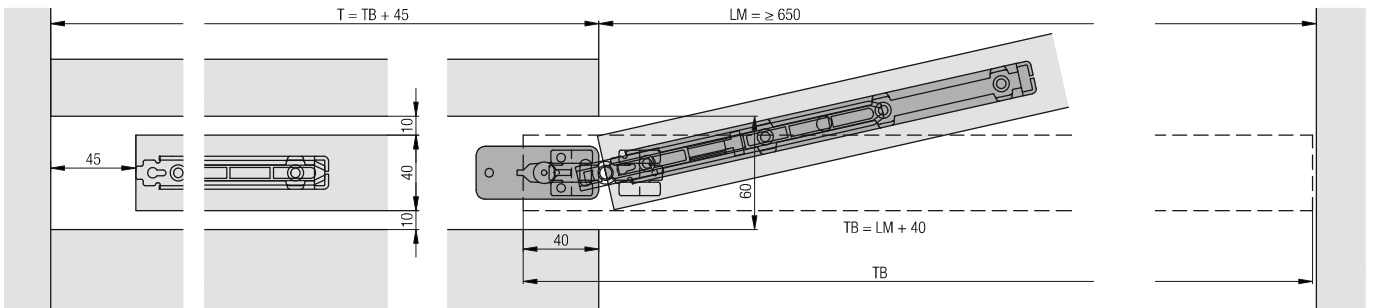

Amortissement

	Z =					
	1			2		
	0	1	2	0	1	2
Hawa Porta 60/100 H/HC	480	535	590	730	785	840
Hawa Porta 60/100 HM/HMD/HMT	480	535	590	730	785	840
Hawa Porta 100 G/GU/GM	480	535	590	730	785	840
Hawa Porta 100 GW/GWF	512	542	590	762	792	840
Hawa Porta 100 GMD	488	539	590	738	789	840
Hawa Divido 100 H/HM/GR	480	535	590	730	785	840
Hawa Divido 100 GRM	512	567	622	762	817	872

Amortissement Push-to-open

Nur für Hawa Porta 100 Pocket
Only for Hawa Porta 100 Pocket
Seulement pour Hawa Porta 100 Pocket

Türgewicht / door weight / poids de la porte 40-100 kg

	Y =	
	0	1
Hawa Porta 100 Pocket	495	800

Empfehlung: Hawa Montageset verwenden
Recommendation: Use the Hawa Assembly set
Recommendation: Utilisez le kit de montage Hawa

Ohne Montageset: Für Montage und Demontage
Push-to-open stirnseitigen Zugang gewährleisten
Without assembly set: For mounting and dismounting
of the Push-to-open ensure a frontal access
Sans kit de montage: Pour le montage et le
démontage du Push-to-open assurez un accès frontal

Nur für Hawa Porta 100 Pocket
Only for Hawa Porta 100 Pocket
Seulement pour Hawa Porta 100 Pocket

Accessoires

- Solutions de fermeture à partir de la page 431
- Accessoires généraux à partir de la page 441

Planification/exécution

Plus d'informations sur le produit sont disponibles sur www.hawa.com.