

NOTICE LEVE PORTAIL

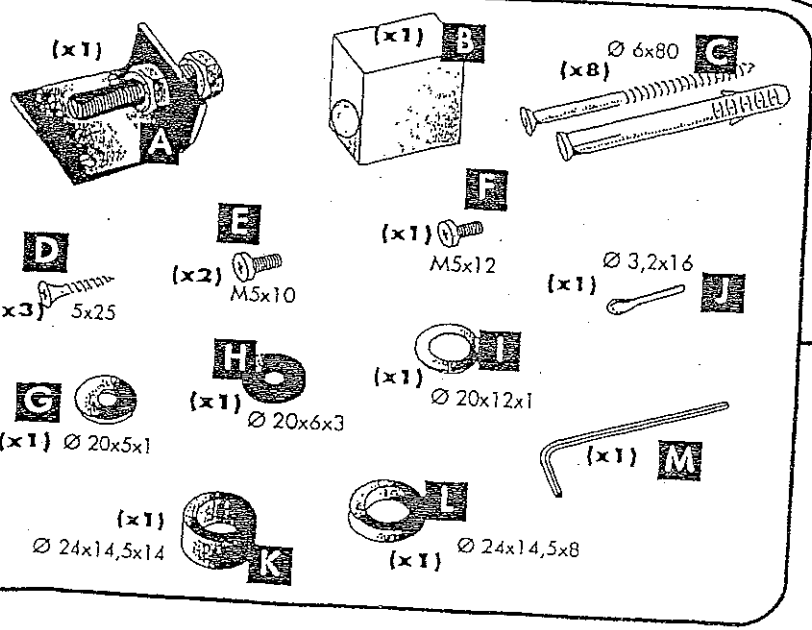
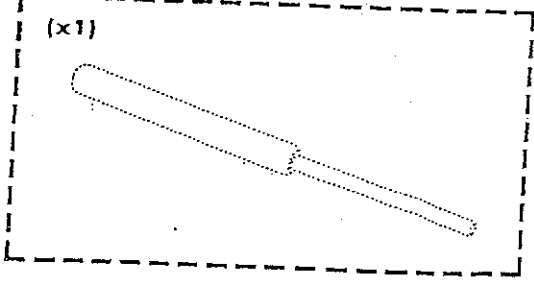
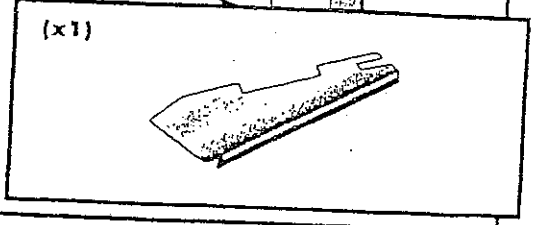
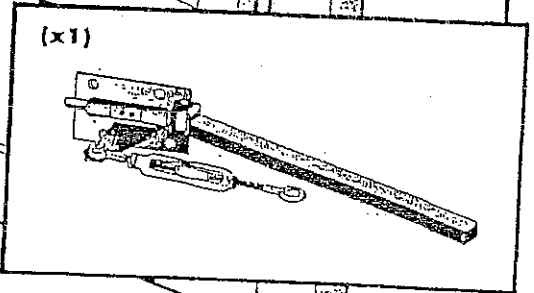
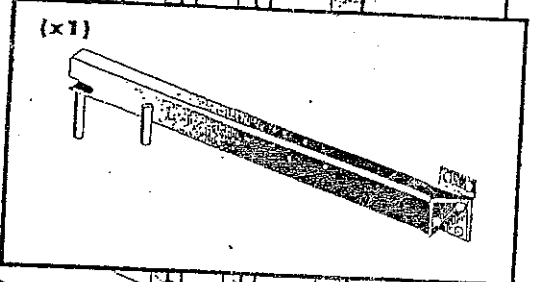
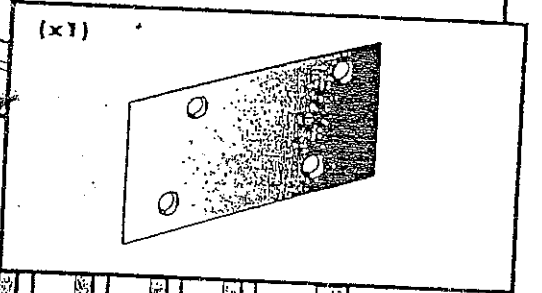
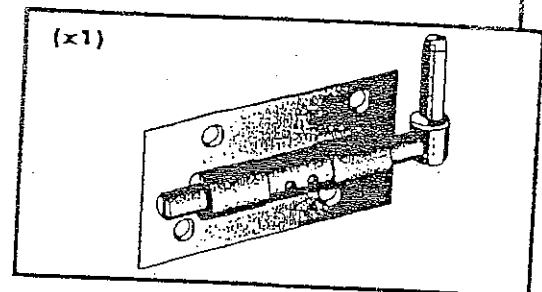
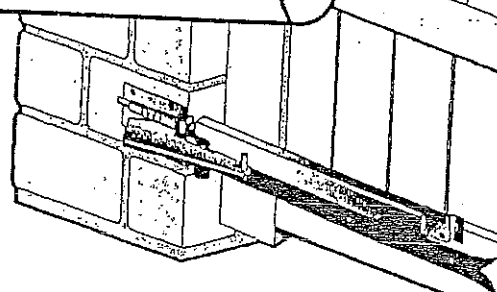
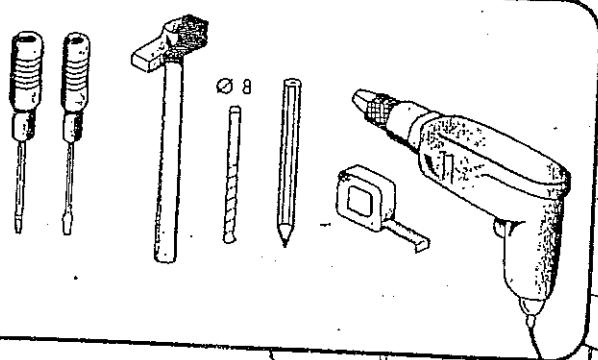
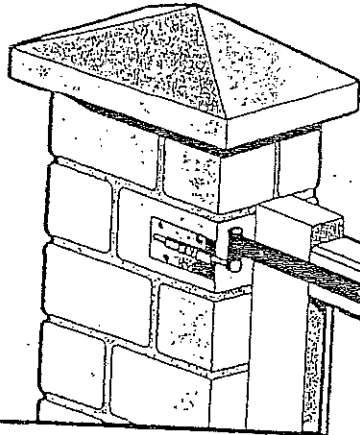

JARDINIER MASSARD →

RENSEIGNEMENTS A RECUEILLIR AVANT LA VENTE DE FERRURES LEVE PORTAIL

1-LONGUEUR DU VANTAIL

2-ECARTEMENT ENTRE PENTURES

3-IMPORTANCE DE LA PENTE

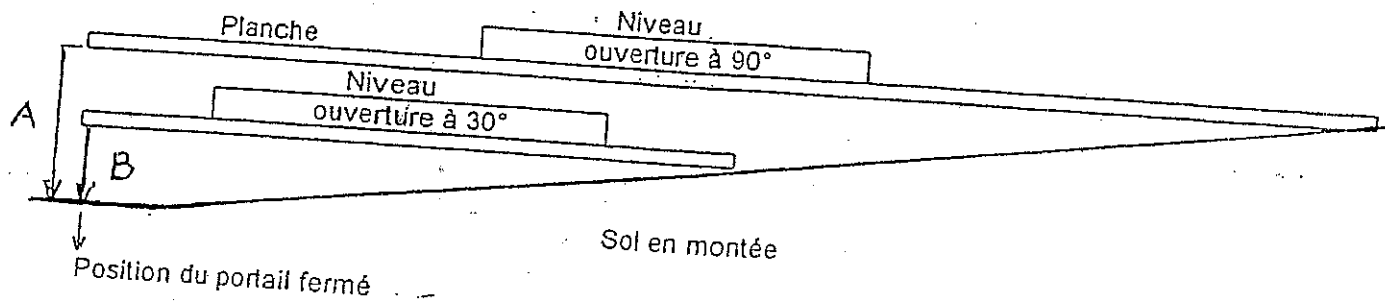
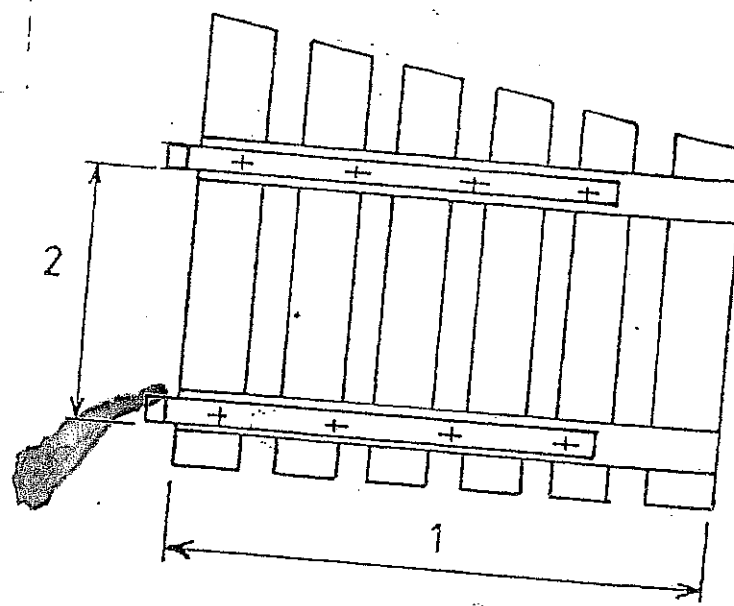

Déterminer l'importance de la pente par rapport à la position fermée=

A = Portail ouvert à 90° = distance du dessous de la planche au sol

B = Portail ouvert à 30° = distance du dessous de la planche au sol

4-POIDS DU VANTAIL

- 35 kg
- 36 à 60 kg
- 61 à 90 kg

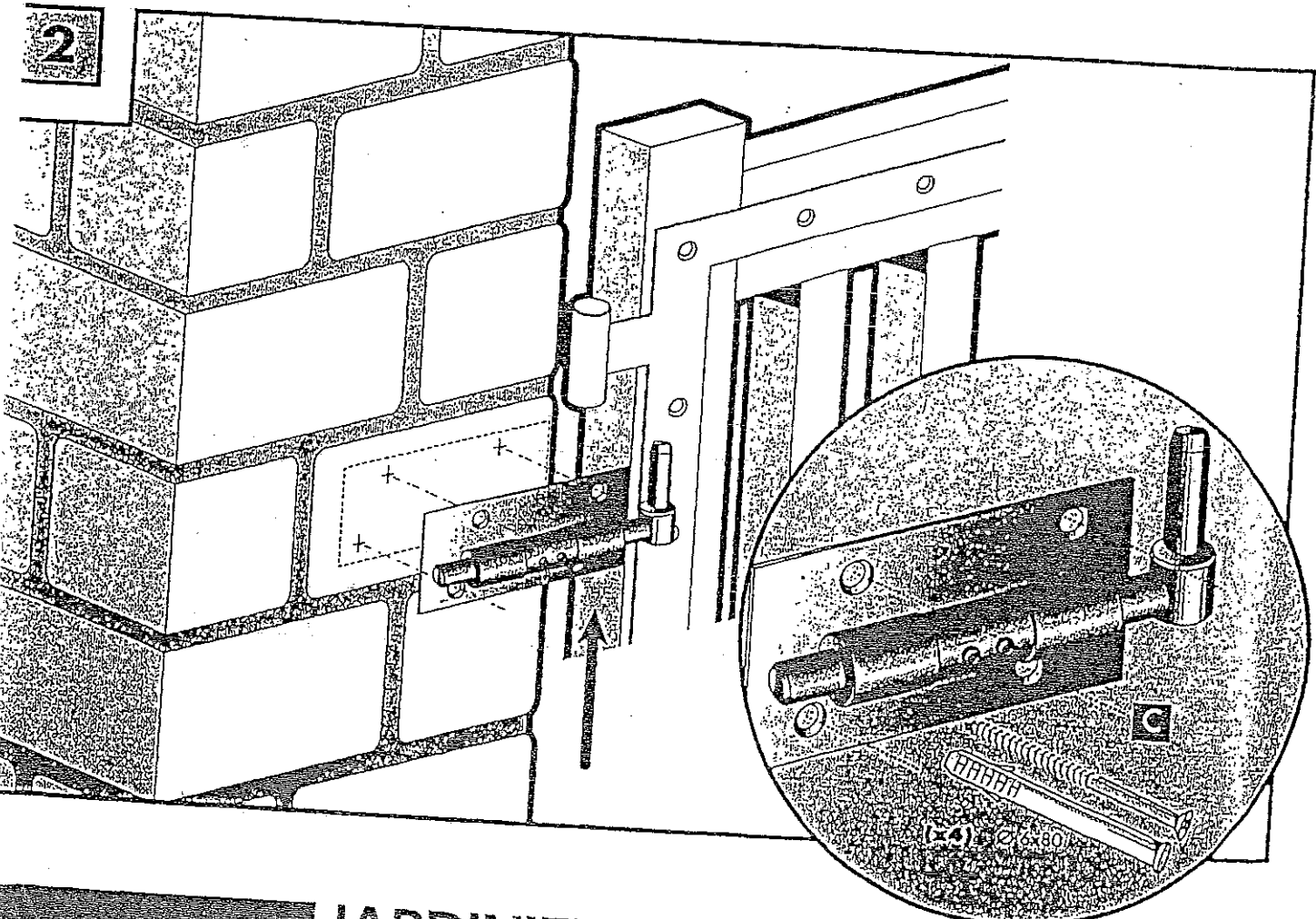
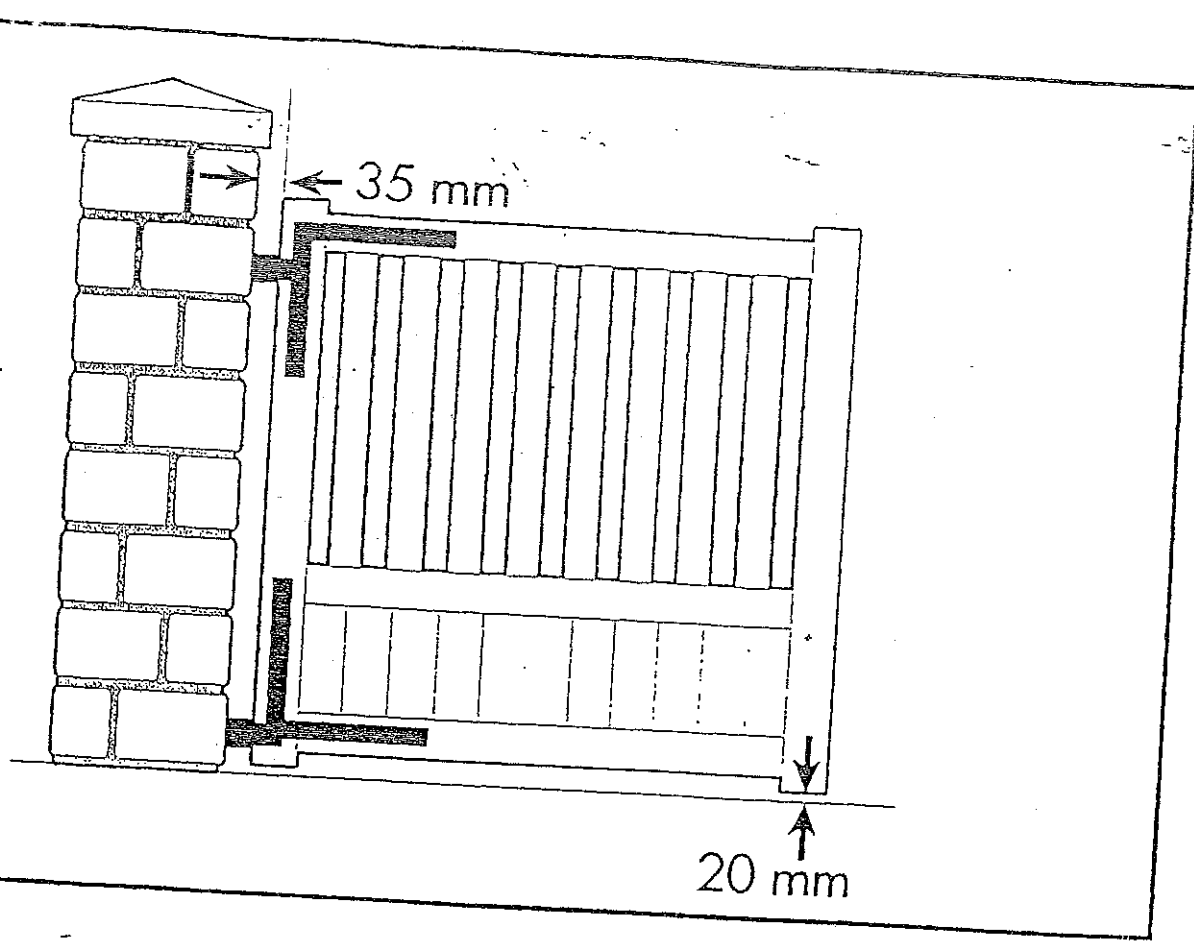

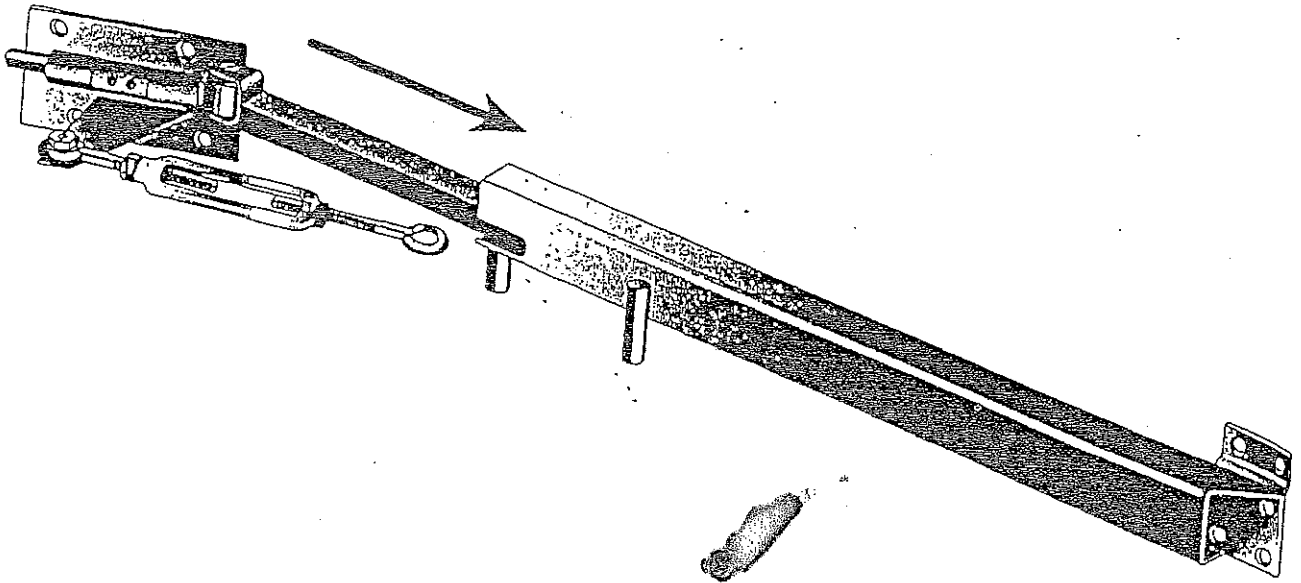

JARDINIER-MASSARD

5



6

 1 Pente douce
2 Pente forte

(x1)  
Ø 20x12x1 Ø 3,2x16

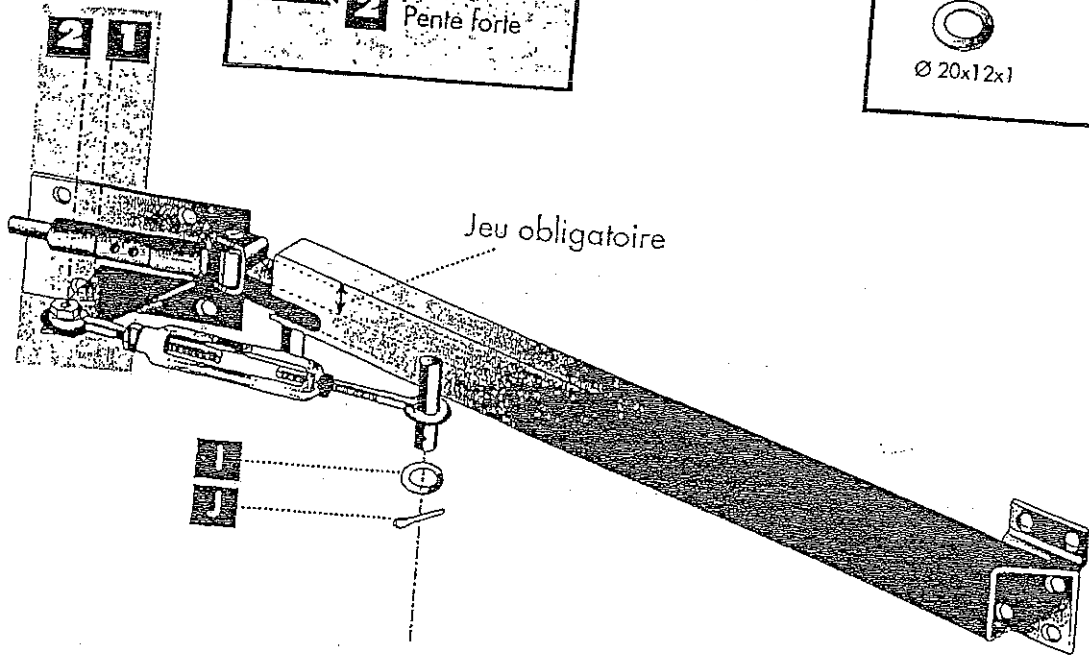

JARDINIER-MASSARD

3

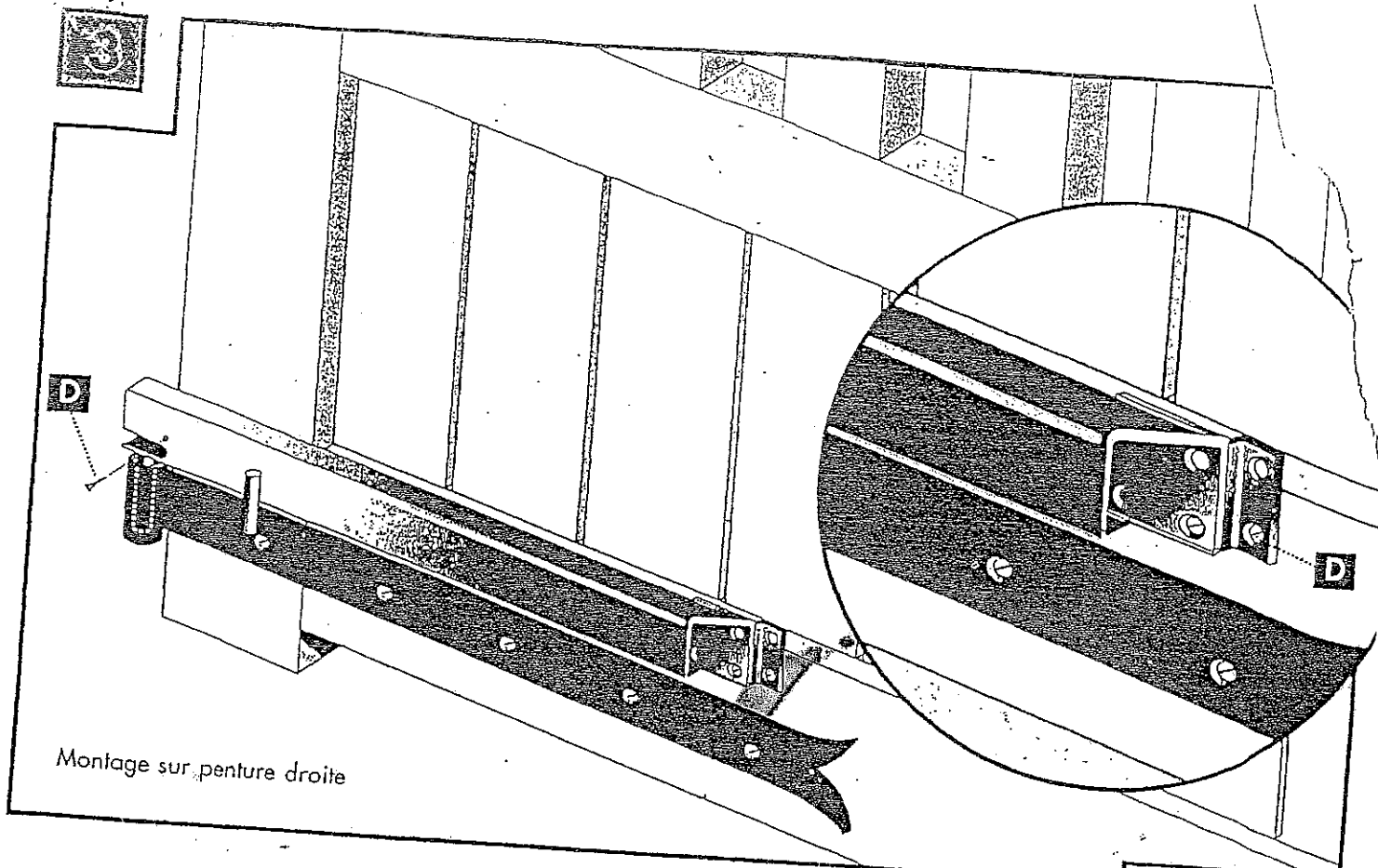

Montage sur penture droite

D
5x25
(x3)

4

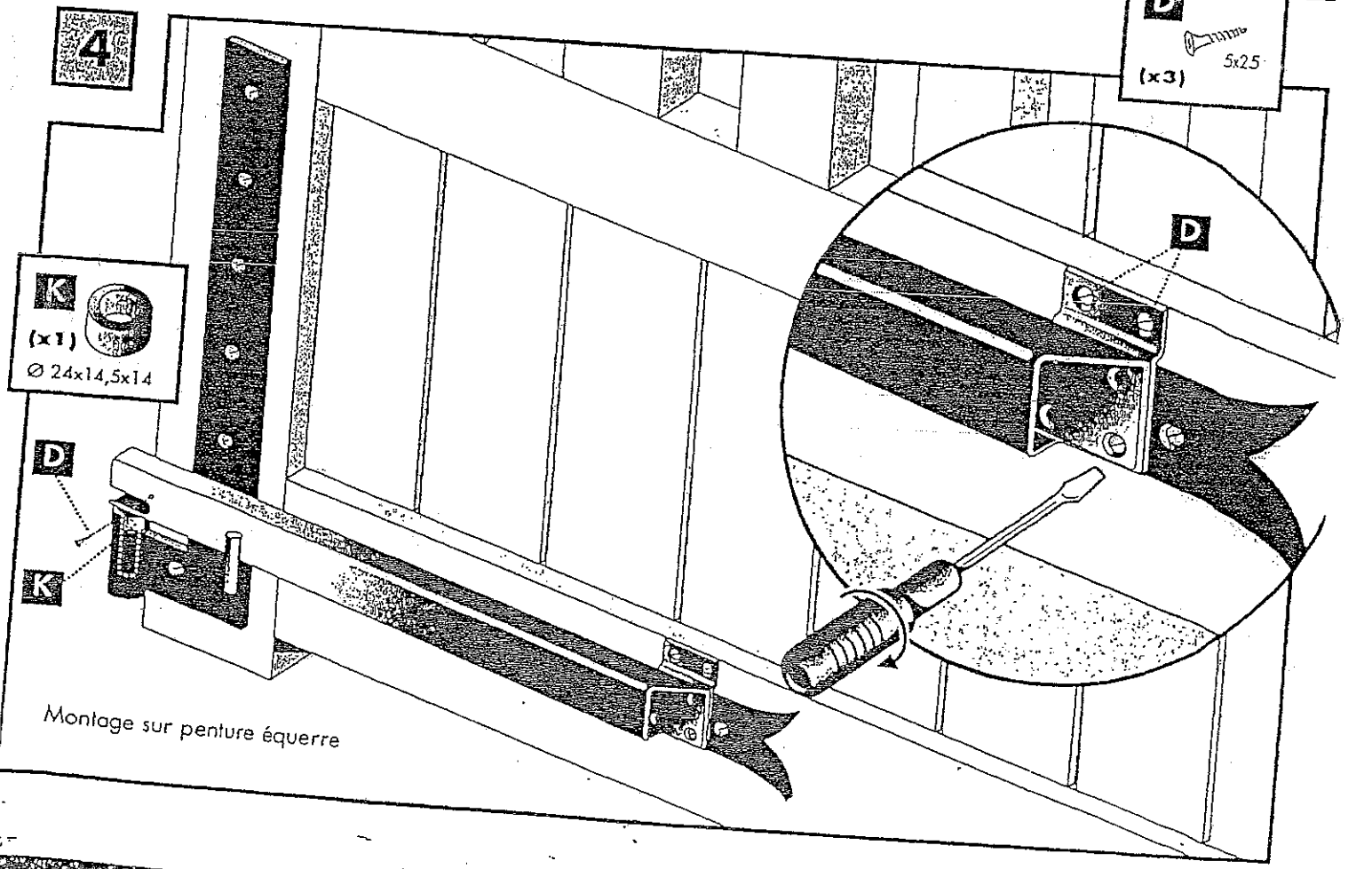

K
(x1)
Ø 24x14,5x14

Montage sur penture équerre

JARDINIER-MASSARD

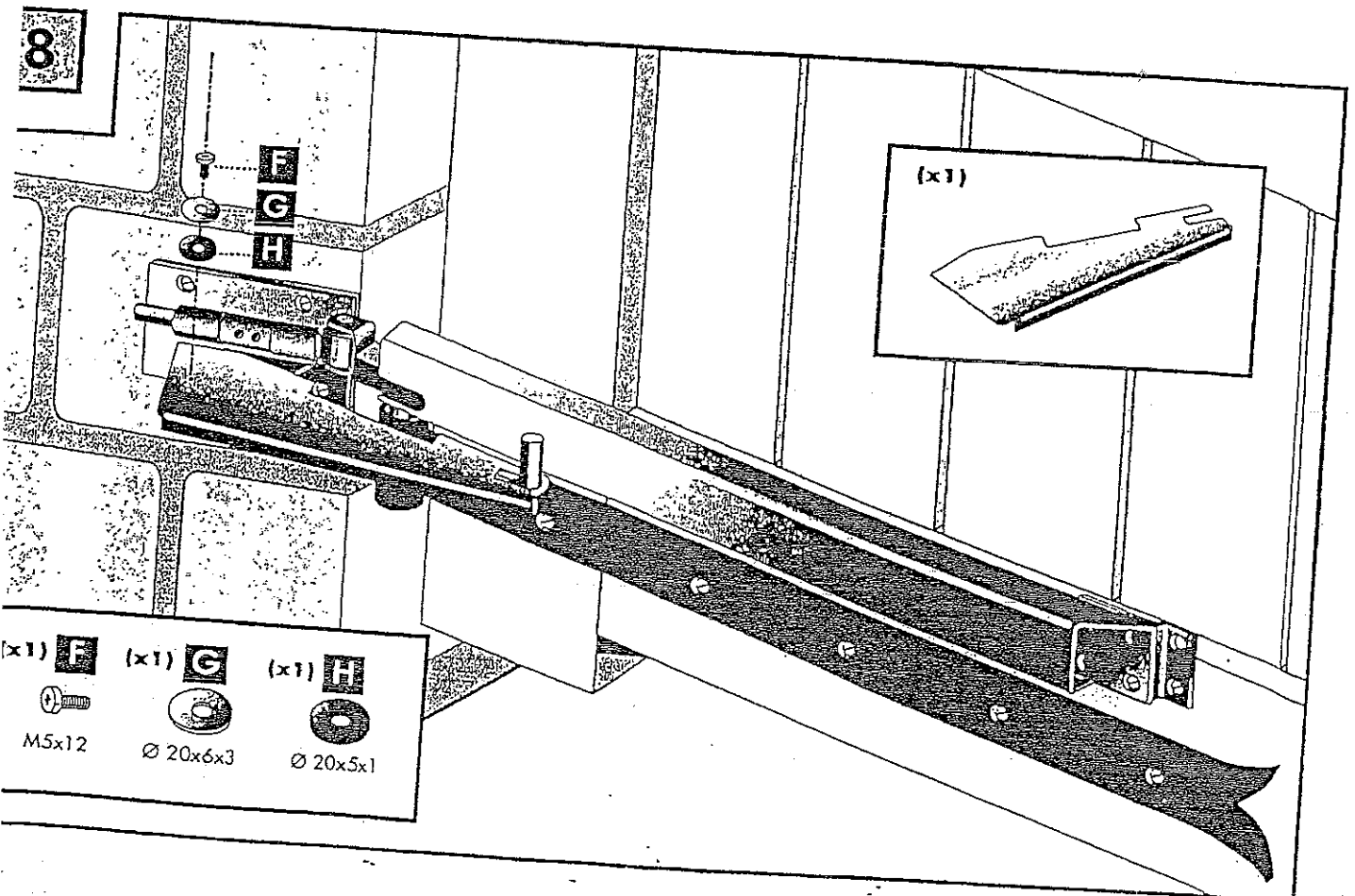
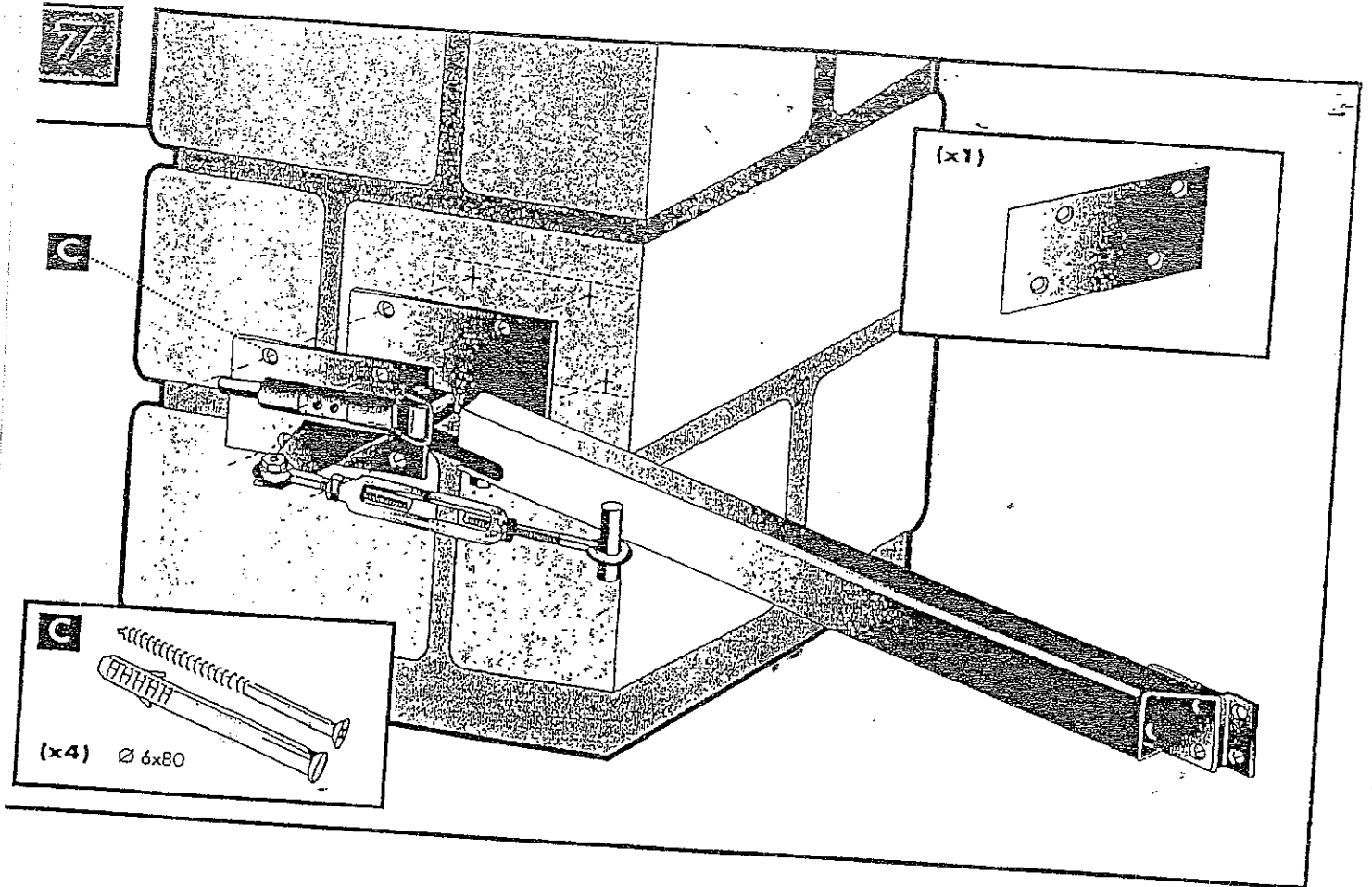

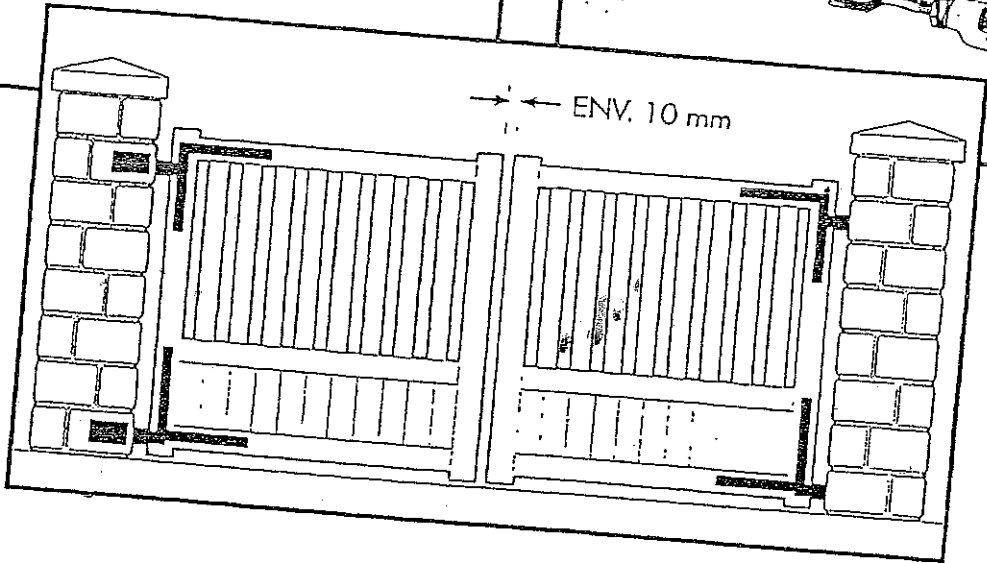
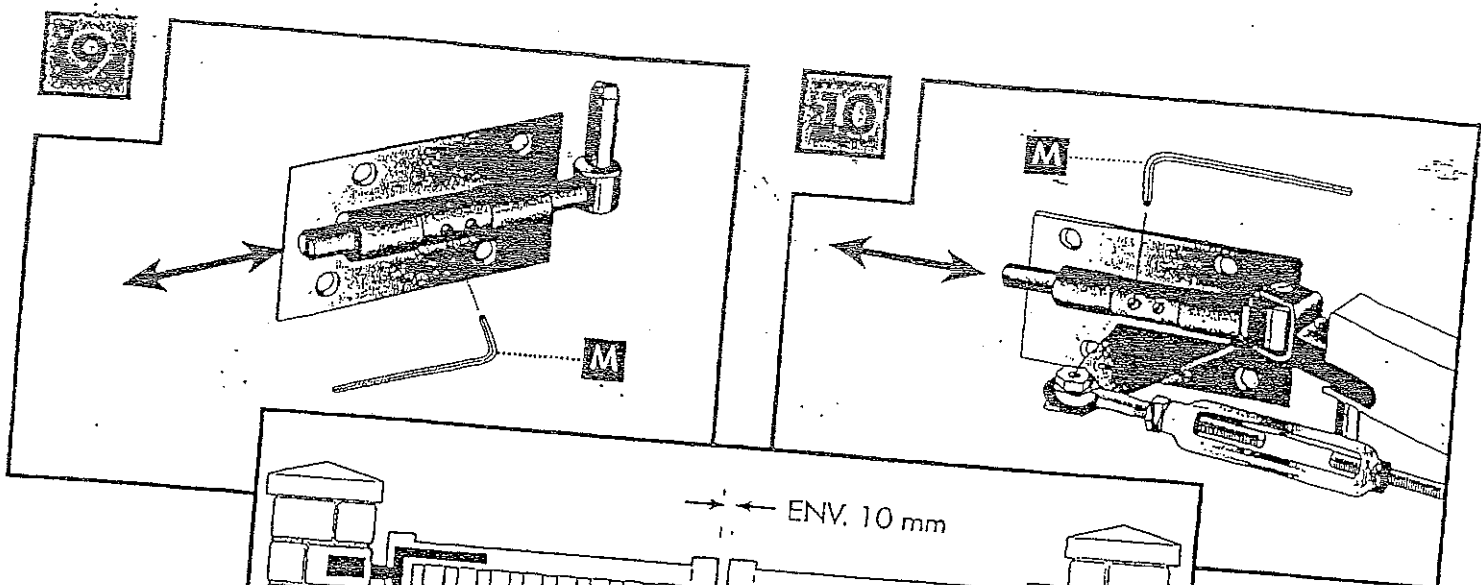

11

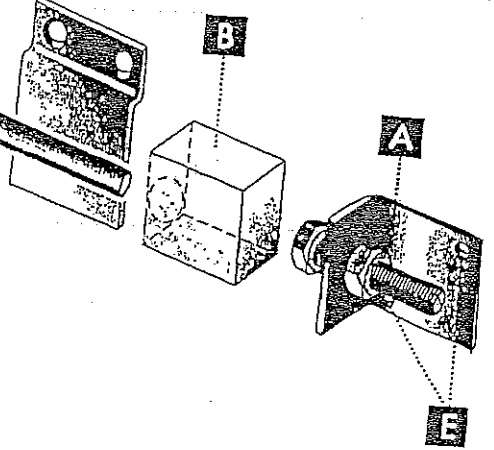
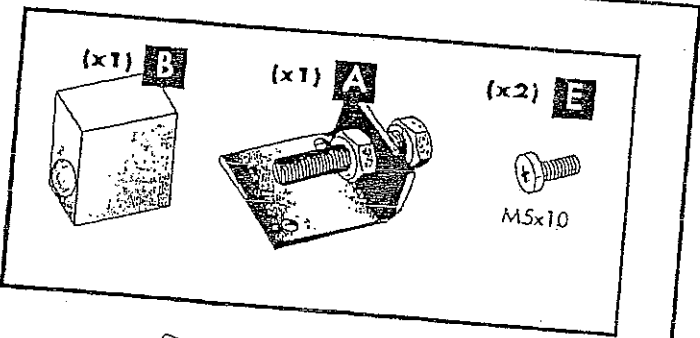
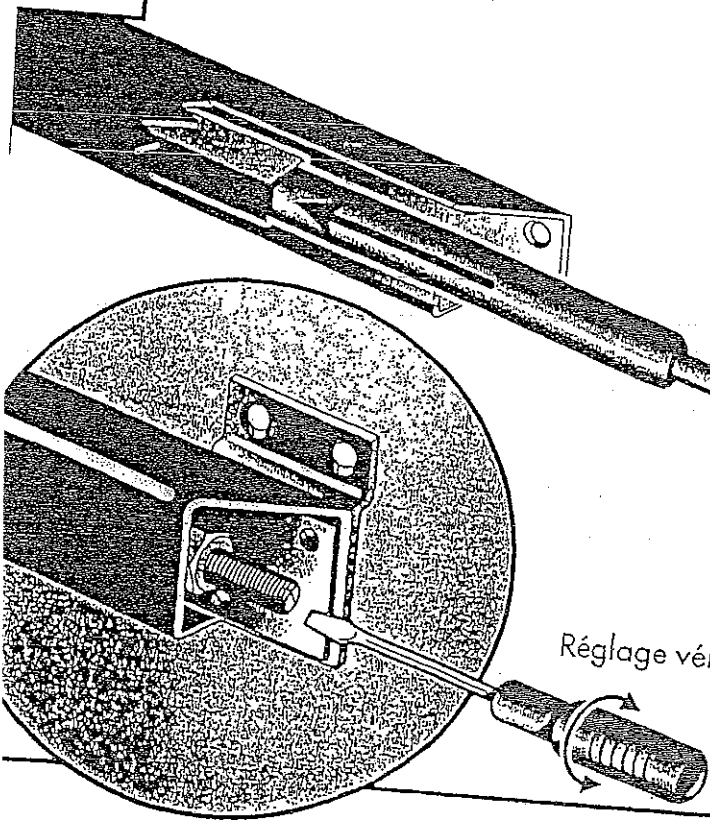

JARDINIER-MASSARD

OUVERTURE DU VANTAIL à 90°

ENTRAXE des GONDS		800	900	1000	1100	1200	1300	1400	1500
Lg VANTAIL	REGLAGE								
1000	1	157	142	131	123	116	110	105	100
	2	180	164	150	140	132	124	117	110
1250	1	189	171	157	147	138	130	124	118
	2	219	200	183	171	160	150	140	131
1500	1	221	200	183	171	160	150	143	136
	2	258	236	216	201	188	175	163	152
1750	1	253	229	209	195	182	170	162	154
	2	297	272	249	232	216	201	186	174
2000	1	286	258	236	218	203	191	180	172
	2	337	307	282	262	244	226	210	195

GARDE AU SOL VANTAIL FERME (environ 25 mm) ↓

REGLAGE 1 = trou le plus près de la platine

REGLAGE 2 = trou le plus éloigné de la platine

OUVERTURE DU VANTAIL à 30° ^{mi-course d'ouverture} (moitié de la pente)

ENTRAXE des GONDS		800	900	1000	1100	1200	1300	1400	1500
Lg VANTAIL	REGLAGE								
1000	1	66	63	59	57	55	53	51	50
	2	78	73	68	64	61	58	56	54
1250	1	75	71	66	63	61	58	56	55
	2	90	84	78	73	69	65	63	61
1500	1	84	79	73	69	66	63	61	60
	2	103	95	88	82	77	73	70	67
1750	1	93	87	80	75	72	68	66	65
	2	115	106	98	91	85	80	77	74
2000	1	102	94	86	81	77	74	72	70
	2	128	118	108	100	94	88	84	80

GARDE AU SOL VANTAIL FERME (environ 25 mm)