

Compact Planar



DECOUVREZ LE COMPACT PLANAR

Généralités

COMPACT PLANAR

De par son habillage comprenant une face plane décorative, le radiateur Compact Planar offre à votre maison un caractère propre et fini. En choisissant le radiateur Compact Planar, vous optez pour un radiateur extrêmement solide avec ce «petit quelque chose en plus»

Produit:	radiateur décoratif habillé à face plane
Finition:	face décorative plane avec grille supérieure et joues
Fourni avec:	consoles VDI (type Monclac), vis, chevilles, bouchon purgeur, bouchon plein et instructions de montage
Raccordements:	4 x ½" à filetage intérieur
Étriers:	2 paires d'étriers jusqu'à 1.600 mm et 3 paires à partir de 1.800 mm
Emballage:	Chaque radiateur est solidement emballé dans un carton de qualité et plastifié. Une étiquette décrit les caractéristiques du radiateur: type – hauteur – longueur:
Garantie:	10 ans sous réserve de respecter les prescriptions concernant les conditions d'installation ainsi que les conditions de garantie de Stelrad.
Procédé de laquage:	Tous les radiateurs sont dégraissés, phosphatés, enduits d'une couche de protection primaire par cataphorèse et d'un poudrage électrostatique dans la couleur blanc Stelrad 9016.
Couleurs:	blanc Stelrad 9016 + 35 autres couleurs de Stelrad ou 200 couleurs RAL
Pression de service max.:	10 bar (testé à 13 bar)
Température max.:	110 °C
Conformité:	selon EN442
Types:	11 21 22 33
Hauteurs:	300 400 500 600 700 900 mm
Longueurs:	400 – 2.000 mm
Profondeurs:	63 79 102 160 mm



Données techniques

Caractéristiques nominales et émissions suivant EN442 75/65/20°C et par mètre de radiateur

Formule caractéristique

$$\Phi = K_M \times \Delta T^n$$

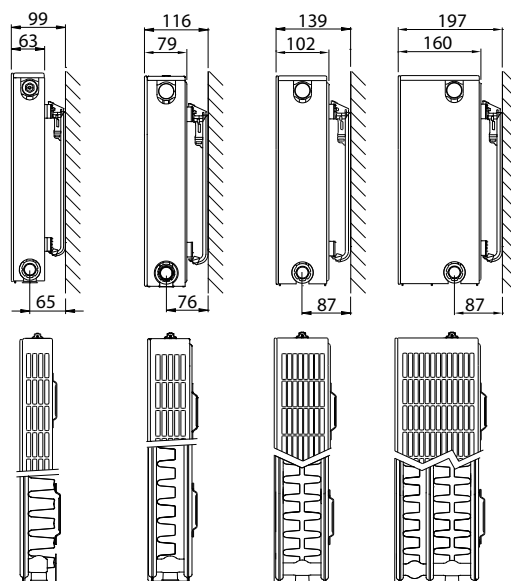

Hauteur						Entraxe d'alimentation
	Type 11	Type 21	Type 22	Type 33		
300	W	469	706	929	1.346	250
	kg	11,88	16,86	19,60	28,00	
	l	1,89	3,70	3,70	5,40	
	m ²	2,09	2,44	3,51	5,26	
	n	1,30	1,32	1,30	1,31	
400	W	626	889	1.177	1.690	350
	kg	16,13	22,87	26,40	38,13	
	l	2,34	4,67	4,67	6,87	
	m ²	2,95	3,37	4,92	7,38	
	n	1,29	1,32	1,30	1,32	
500	W	774	1.062	1.411	2.017	450
	kg	20,39	28,89	33,20	48,27	
	l	2,80	5,63	5,63	8,33	
	m ²	3,80	4,31	6,33	9,49	
	n	1,28	1,32	1,31	1,33	
600	W	911	1.227	1.634	2.332	550
	kg	24,65	34,90	40,00	58,40	
	l	3,25	6,60	6,60	9,80	
	m ²	4,66	5,24	7,74	11,61	
	n	1,27	1,32	1,32	1,34	
700	W	1.038	1.387	1.848	2.637	650
	kg	28,91	40,91	46,80	68,53	
	l	3,77	7,63	7,63	11,37	
	m ²	5,51	6,18	9,15	13,72	
	n	1,28	1,32	1,33	1,34	
900	W	1.260	1.690	2.251	3.225	850
	kg	37,43	52,94	60,40	88,80	
	l	4,80	9,70	9,70	14,50	
	m ²	7,22	8,05	11,97	17,96	
	n	1,29	1,31	1,35	1,34	

W=puissance par mètre / kg=poids par mètre / l=contenance par mètre / m²=surface par mètre / n=pente
Le fabricant se réserve le droit de changer les spécifications sans avis préalable.

COMPACT PLANAR

Émissions calorifiques suivant EN442

10 ANS GARANTIE

EN442 (W) 70/50/20°C

EN442 (W) 55/45/20°C

Stelrad BV/PLI 18(0149)E008

Hauteur	300			
	11	21	22	33
Type				
W/m 75/65/20°C	469	706	929	1.346
400	141 97 0216031104	210 144 0216032104	279 192 0216032204	401 275 0216033304
500	175 120 0216031105	263 180 0216032105	347 239 0216032205	502 344 0216033305
600	210 145 0216031106	316 216 0216032106	417 287 0216032206	603 413 0216033306
700	245 169 0216031107	368 252 0216032107	487 335 0216032207	703 482 0216033307
800	280 193 0216031108	421 288 0216032108	556 383 0216032208	804 551 0216033308
900	316 217 0216031109	473 324 0216032109	626 431 0216032209	904 619 0216033309
1000	351 241 0216031110	526 360 0216032110	696 479 0216032210	1.004 689 0216033310
1100	386 265 0216031111	579 397 0216032111	765 527 0216032211	1.105 758 0216033311
1200	421 290 0216031112	631 432 0216032112	835 575 0216032212	1.205 826 0216033312
1400	491 338 0216031114	737 504 0216032114	974 671 0216032214	1.406 964 0216033314
1600		842 577 0216032116	1.113 767 0216032216	1.607 1.102 0216033316
1800		948 649 0216032118	1.252 863 0216032218	1.808 1.239 0216033318
2000		1.053 721 0216032120	1.391 958 0216032220	2.009 1.377 0216033320

400			
11	21	22	33
626	889	1.177	1.690
187 129 0216041104	265 182 0216042104	352 242 0216042204	503 344 0216043304
235 162 0216041105	331 226 0216042105	440 302 0216042205	629 430 0216043305
282 194 0216041106	397 272 0216042106	528 363 0216042206	755 516 0216043306
328 226 0216041107	463 317 0216042107	616 423 0216042207	881 602 0216043307
376 259 0216041108	530 363 0216042108	704 484 0216042208	1.007 688 0216043308
422 291 0216041109	596 408 0216042109	792 544 0216042209	1.132 774 0216043309
469 324 0216041110	662 453 0216042110	880 605 0216042210	1.258 860 0216043310
516 356 0216041111	729 499 0216042111	968 665 0216042211	1.384 946 0216043311
563 388 0216041112	795 544 0216042112	1.055 725 0216042212	1.510 1.032 0216043312
657 453 0216041114	928 635 0216042114	1.232 847 0216042214	1.761 1.204 0216043314
751 518 0216041116	1.060 725 0216042116	1.408 967 0216042216	2.013 1.376 0216043316
845 583 0216041118	1.192 816 0216042118	1.584 1.088 0216042218	2.265 1.548 0216043318
939 647 0216041120	1.325 907 0216042120	1.760 1.209 0216042220	2.516 1.720 0216043320

500			
11	21	22	33
774	1.062	1.411	2.017
233 161 0216051104	317 216 0216052104	421 289 0216052204	599 409 0216053304
291 201 0216051105	395 270 0216052105	527 361 0216052205	749 510 0216053305
349 241 0216051106	474 324 0216052106	632 433 0216052206	899 613 0216053306
407 282 0216051107	553 378 0216052107	737 505 0216052207	1.049 715 0216053307
465 322 0216051108	633 433 0216052108	842 578 0216052208	1.199 817 0216053308
524 362 0216051109	712 487 0216052109	948 650 0216052209	1.348 919 0216053309
582 402 0216051110	791 541 0216052110	1.053 722 0216052210	1.498 1.021 0216053310
639 442 0216051111	870 595 0216052111	1.158 794 0216052211	1.648 1.123 0216053311
698 483 0216051112	949 649 0216052112	1.263 866 0216052212	1.798 1.225 0216053312
814 563 0216051114	1.107 757 0216052114	1.474 1.010 0216052214	2.098 1.430 0216053314
930 643 0216051116	1.265 865 0216052116	1.685 1.155 0216052216	2.397 1.634 0216053316
1.047 724 0216051118	1.424 974 0216052118	1.895 1.299 0216052218	2.697 1.838 0216053318
1.163 804 0216051120	1.582 1.082 0216052120	2.106 1.444 0216052220	2.996 2.042 0216053320

COMPACT PLANAR

Art. 0216 09 22 04

 COMPACT PLANAR T11-33: 0216
 

Hauteur	600			
	11	21	22	33
Type	11	21	22	33
W/m 75/65/20°C	911	1.227	1.634	2.332
400	274 190 0216061104	365 250 0216062104	487 333 0216062204	691 470 0216063304
500	343 238 0216061105	457 312 0216062105	608 416 0216062205	864 587 0216063305
600	412 286 0216061106	548 374 0216062106	730 499 0216062206	1.037 705 0216063306
700	480 333 0216061107	639 437 0216062107	852 583 0216062207	1.209 822 0216063307
800	549 381 0216061108	731 500 0216062108	973 666 0216062208	1.383 940 0216063308
900	617 428 0216061109	822 562 0216062109	1.096 749 0216062209	1.556 1.057 0216063309
1000	686 476 0216061110	913 624 0216062110	1.217 832 0216062210	1.728 1.174 0216063310
1100	754 523 0216061111	1.005 687 0216062111	1.338 915 0216062211	1.901 1.292 0216063311
1200	823 571 0216061112	1.096 749 0216062112	1.460 999 0216062212	2.074 1.409 0216063312
1400	960 666 0216061114	1.279 874 0216062114	1.704 1.165 0216062214	2.420 1.644 0216063314
1600	1.098 761 0216061116	1.461 999 0216062116	1.947 1.331 0216062216	2.765 1.879 0216063316
1800	1.235 857 0216061118	1.644 1.124 0216062118	2.190 1.498 0216062218	3.111 2.114 0216063318
2000	1.372 952 0216061120	1.827 1.249 0216062120	2.434 1.665 0216062220	3.457 2.349 0216063320

700			
11	21	22	33
1.038	1.387	1.848	2.637
312 216 0216071104	413 283 0216072104	549 374 0216072204	782 531 0216073304
390 270 0216071105	517 354 0216072105	686 468 0216072205	977 664 0216073305
468 324 0216071106	620 424 0216072106	824 562 0216072206	1.172 796 0216073306
547 378 0216071107	723 495 0216072107	961 655 0216072207	1.368 929 0216073307
624 432 0216071108	827 566 0216072108	1.098 749 0216072208	1.563 1.062 0216073308
702 486 0216071109	930 636 0216072109	1.235 842 0216072209	1.758 1.195 0216073309
780 540 0216071110	1.033 707 0216072110	1.373 936 0216072210	1.954 1.328 0216073310
859 594 0216071111	1.137 778 0216072111	1.510 1.030 0216072211	2.150 1.461 0216073311
937 649 0216071112	1.239 848 0216072112	1.648 1.123 0216072212	2.344 1.593 0216073312
1.092 756 0216071114	1.447 989 0216072114	1.922 1.310 0216072214	2.736 1.859 0216073314
1.249 865 0216071116	1.653 1.131 0216072116	2.197 1.498 0216072216	3.126 2.124 0216073316
1.404 972 0216071118	1.860 1.272 0216072118	2.471 1.684 0216072218	3.517 2.390 0216073318
1.561 1.081 0216071120	2.066 1.413 0216072120	2.746 1.872 0216072220	3.908 2.655 0216073320

900			
11	21	22	33
1.260	1.690	2.251	3.225
378 261 0216091104	504 345 0216092104	665 451 0216092204	956 649 0216093304
472 326 0216091105	630 432 0216092105	832 564 0216092205	1.194 811 0216093305
567 391 0216091106	756 518 0216092106	999 676 0216092206	1.433 973 0216093306
661 456 0216091107	882 605 0216092107	1.165 789 0216092207	1.673 1.136 0216093307
756 521 0216091108	1.008 691 0216092108	1.331 902 0216092208	1.911 1.298 0216093308
850 586 0216091109	1.134 777 0216092109	1.498 1.014 0216092209	2.150 1.460 0216093309
945 651 0216091110	1.260 864 0216092110	1.664 1.127 0216092210	2.389 1.622 0216093310
1.039 717 0216091111	1.386 950 0216092111	1.830 1.240 0216092211	2.628 1.785 0216093311
1.133 782 0216091112	1.513 1.036 0216092112	1.997 1.352 0216092212	2.867 1.947 0216093312
1.322 912 0216091114	1.765 1.209 0216092114	2.329 1.578 0216092214	3.344 2.271 0216093314
1.511 1.042 0216091116	2.017 1.382 0216092116	2.662 1.803 0216092216	3.822 2.596 0216093316
1.700 1.173 0216091118	2.269 1.554 0216092118	2.995 2.029 0216092218	4.300 2.920 0216093318
1.889 1.303 0216091120	2.521 1.727 0216092120	3.328 2.254 0216092220	4.778 3.245 0216093320

MODES DE RACCORDEMENT

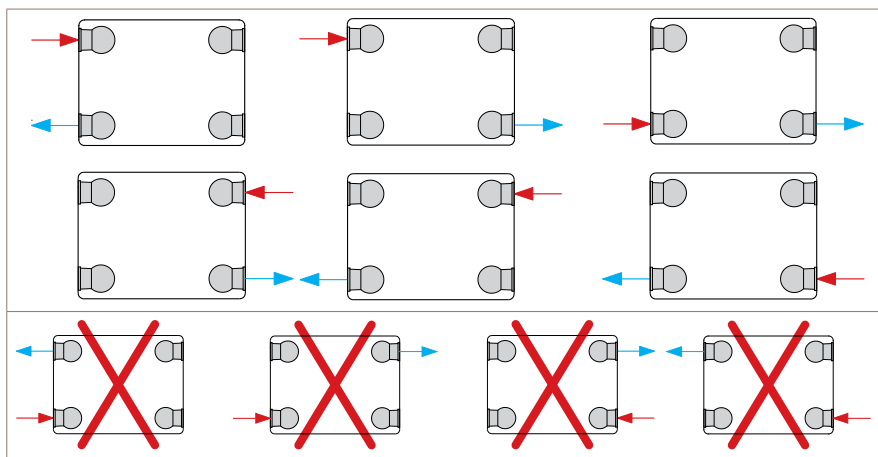

DIMENSIONS DE RACCORDEMENT

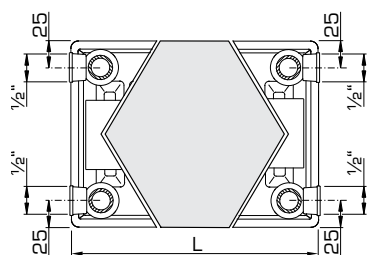

CONSOLES J (TYPE MONCLAC VDI 6036)

Type 11

Type 21

Type 22

Type 33

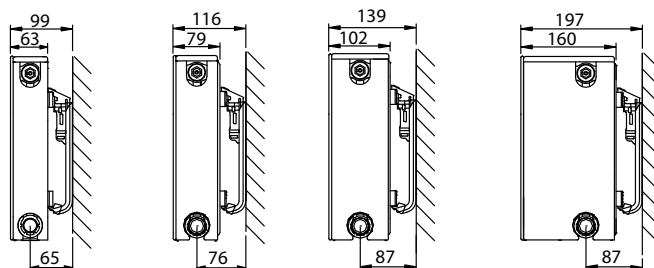

Type 11-33	x	x	N° d'art. (2 pc.)	N° d'art. (3 pc.)	Hauteur
	/	140	R509203	R509303	300
	103	240	R509204	R509304	400
	103	340	R509205	R509305	500
	103	440	R509206	R509306	600
	103	540	R509207	R509307	700
	103	740	R509209	R509309	900

À partir de L 1800 mm: 3 consoles.

POSITIONS DES ÉTRIERS

Type 21/22/33

L	A
400-1600	133

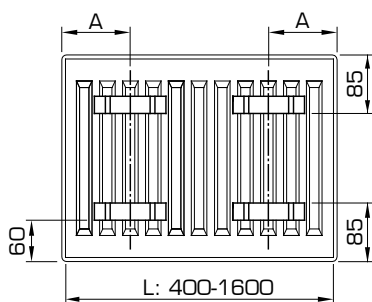

Type 21/22/33

L	A
1800-3000	133

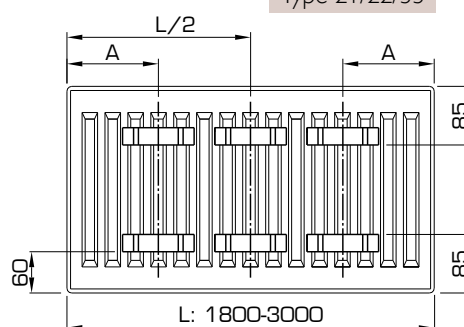

Type 11

L	A
400	117
500-1600	150

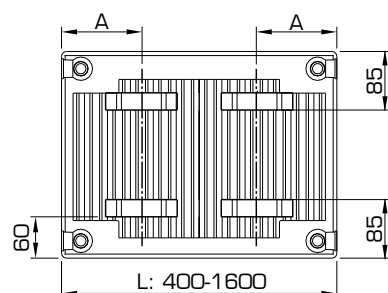

Type 11

L	A
1800-3000	150

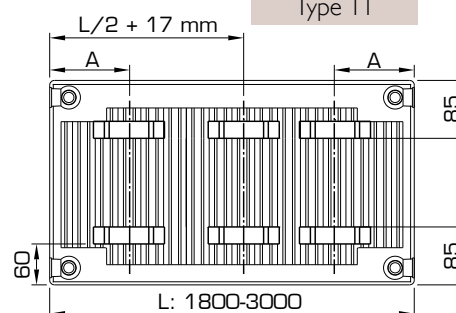

SALES TEAM BELGIQUE

Steven Goos

Délégué Commercial, Anvers,
Flandre Orientale & Occidentale
+32 (0)496 25 04 17
steven.goos@srg.eu

Pana Tsanaktsidis

Délégué Commercial, Bruxelles,
Limbourg & Brabant Flamand
+32 (0)496 16 21 11
pana.t@srg.eu

Philippe Legrain

Délégué Commercial, Wallonie & Luxembourg
+32 (0)496 52 19 29
philippe.legrain@srg.eu

SALES TEAM FRANCE

Jean-Louis Degremont

Délégué Commercial, Normandie, Bourgogne, Rhone Alpes, Centre,
Pays De La Loire, Poitou-Charentes, Limousin (Dép. 87 & 23) et Auvergne
+33 (0)612 11 12 34
jean-louis.degremont@srg.eu

Philippe Legrain

Délégué Commercial, Bretagne, Nord-Pas-De-Calais, Picardie,
Champagne Ardennes, Lorraine, Alsace & Franche-Comte
+32 (0)496 52 19 29
philippe.legrain@srg.eu

Laurent Lotz

Délégué Commercial, Ile De France
+32 (0)643 35 41 49
laurent.lotz@srg.eu

Thierry Theuret

Délégué Commercial Aquitaine, Midi-Pyrennees,
Languedoc Roussillon, Limousin (Dép. 19)
+33 (0)6 15 15 17 30
thierry.theuret@srg.eu

ECO

DESIGN

DECO

SPECIAL

STANDARD

SALLE DE BAIN



Bert Scholtissen

Sales Support Manager
+31 (0)653 40 53 23
bert.scholtissen@srg.eu

Agence France

commandes à envoyer à:
wendy.vermeerbergen@srg.eu
+32 (0)14 21 17 19

Koen Mannaerts

Directeur Commercial Europe
koen.mannaerts@srg.eu

STELRAD

Caradon Stelrad B.V. | Kathagen 30 | 6361 HG Nuth | T. +31 (0)455 65 62 62 | F. +31 (0)455 65 62 42

WWW.STELRAD.EU



Stelrad
Europe's favourite radiator