



Notice de Montage

**DOUBLE CARPORT
ALUMINIUM TOIT 1/2 ROND**

Réf : CAR 6048 ALRP(T)

DOUBLE CARPORT ALUMINIUM TOIT ½ ROND

Réf : CAR 6048 ALRP (T)

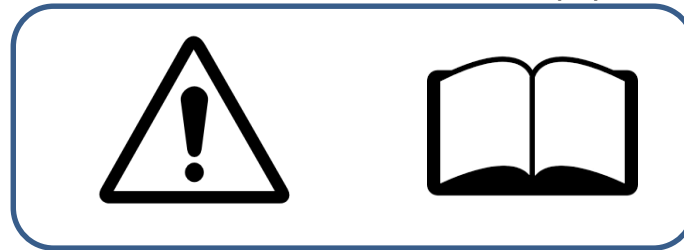

**NOTICE A LIRE ATTENTIVEMENT ET A CONSERVER
EN CAS DE PRÊT OU DE VENTE DU CARPORT VOUS DEVEZ COMMUNIQUER CETTE NOTICE A L'ACQUEREUR**

ATTENTION

- Il est formellement interdit de monter sur le toit du carport.
- En cas de chute de neige importante, supérieure à 5 cm, vous devez obligatoirement déneiger le toit de celui-ci afin d'éviter une surcharge importante et le risque de celle-ci. La société FORESTA sera déchargée de toute responsabilité en cas de litige lié à une surcharge due à la neige.

IMPORTANT

Le carport toit ½ rond ne peut être installé dans les zones dont l'altitude est supérieure à 500 m.

IMPORTANT



ATTENTION :

- Ce carport est fabriqué avec des matériaux qualitatifs. Les carports HABRITA proposent de l'espace de rangement et de la protection contre les dommages causés par le soleil, la pluie légère, la sève, les excréments d'animaux ou d'oiseaux et un peu de neige. Veuillez à ancrer correctement la structure du carport FORESTA. Consulter le guide pour connaître les détails sur son ancrage. Il incombe à l'utilisateur d'assurer un ancrage adéquat et de garder le toit correctement posé et exempt de neige et de débris. Veuillez à lire et vous assurer de bien comprendre les détails de l'installation, les avertissements et les mises en garde avant d'entreprendre l'installation des carports HABRITA.

SECURITE :

- Certaines pièces peuvent être coupantes. Il faut être prudent lors de la manipulation des éléments.
- Toujours porter des gants, des lunettes de protection et des vêtements à manches longues lors de l'assemblage ou pendant toute opération de maintenance sur votre produit.
- Ne pas tenter de construire le produit dans des conditions venteuses ou humides. Pour éviter les blessures, ne pas laisser les enfants jouer autour ou à proximité de la zone d'assemblage du produit.
- Ne pas grimper ou ne pas se tenir debout sur le toit du produit.

DANGER :

- Avant d'entreprendre l'installation, vérifier les autorisations nécessaires et les réglementations auprès de votre mairie concernant les abris temporaires.
- Choisir correctement l'emplacement où placer votre carport.
- Placer le produit à l'abri des vents dominants.
- Ne pas placer la porte ou l'ouverture face aux vents dominants.
- Choisir votre emplacement avant de commencer le montage. Vous assurer que la surface de montage est nivelée et qu'il n'y a pas d'objets pointus afin d'éviter tous risques de rayures ou de dommages sur le produit.
- VOUS TENIR ELOIGNE DES FILS ELECTRIQUES.
- Eviter les lignes électriques, les branches d'arbres et les autres types de structures. Avant de creuser, vérifier la présence de tuyaux ou de fils enfouis. Ne pas installer le carport HABRITA à proximité d'un toit ou de toute autre structure pouvant laisser tomber de la neige, de la glace ou des débris. Ne Suspendre AUCUN objet au toit ou aux câbles de soutien.
- Attention, en cas de non respect des recommandations de montage, la garantie ne pourra pas être appliquée.

IMPORTANT

ATTENTION :

- Ne pas fumer et n'utiliser aucun dispositif produisant des flammes (barbecue, foyer, friteuse, bougie, lanterne) à proximité du carport. Ne pas ranger des liquides inflammables (essences, kérosène, pétrole lampant, etc..) à proximité du carport. Ne pas exposer le dessus ou les parois du carport au feu ou à toute source de d'incendie.

ANCRAGE ET INSTALLATION DE L'ARMATURE :

- IL INCOMBE A L'UTILISATEUR D'ASSURER L'ANCRAGE ADEQUAT DE L'ARMATURE.
- Le fabricant n'assume aucune responsabilité pour les dommages causés au carport ou à son contenu par les catastrophes naturelles ou évènements particuliers. Tout carport n'étant pas ancré solidement risque de se déplacer et de causer des dommages, qui ne seront pas imputables au fabricant.
- Vérifier périodiquement les ancrages pour assurer la stabilité du carport.
- Le fabricant ne peut être tenu pour responsable si le produit commet des dégâts chez son propriétaire ou à l'extérieur de la propriété de celui-ci.

- Dès l'achat de votre carport, penser à faire la déclaration d'achat auprès de votre assurance afin d'être couvert en cas de tempête ou autres conditions météorologiques aboutissant à une détérioration du carport et d'être couvert lors d'une intempérie majeure déclarée « catastrophe naturelle » .
- Nous garantissons la fourniture des pièces détachées durant 2 ans à compter de l'achat du produit.

INFORMATIONS COMPLEMENTAIRES

LA GARANTIE NE CONCERNE PAS :

- Les griffes, empreintes, éclats, coups ou brûlures – les défauts ou détériorations provoqués par un usage différent de celui pour lequel le produit a été conçu, par une mauvaise utilisation ou par le non-respect de la notice de montage, guide de pose ou des conseils d'utilisation et d'entretien ;
- Les détériorations ou défauts provoqués lors de la livraison, de l'installation ou du montage, par le distributeur, l'installateur ou le consommateur ;
- Les défauts d'aspect visibles lors de la livraison du produit ;
- Les modifications d'aspect du produit consécutives à l'usage, en particulier pour les éléments soumis à l'usure ;
- Les produits qui ont été entreposés dans des conditions inadaptées ;

Délais de la garantie :

- La garantie prend effet le jour d'achat par le consommateur et est valable 10 ans sur la structure et 2 ans sur la couverture ;
- La garantie couvre les pièces reconnues défectueuses par FORESTA, tels que les vices de fabrication matière-première.

Demande de garantie :

- Toute demande de garantie doit être formulée au revendeur uniquement ;
- Accompagner votre demande d'une description écrite et claire de l'avarie constatée, ainsi que de photos claires, précises et détaillées.

IMPORTANT

Au moment de la livraison du produit :

- Procéder à l'inventaire complet des pièces avant de commencer le montage.
- En cas de doute sur l'état d'une pièce, ne pas commencer le montage et solliciter une prestation de garantie par écrit en recommandé avec accusé de réception, dans les 10 jours maximum qui suivent la réception du colis.
- Le montage du produit doit être réalisé 1 mois maximum après la livraison du produit.

A NOTER :



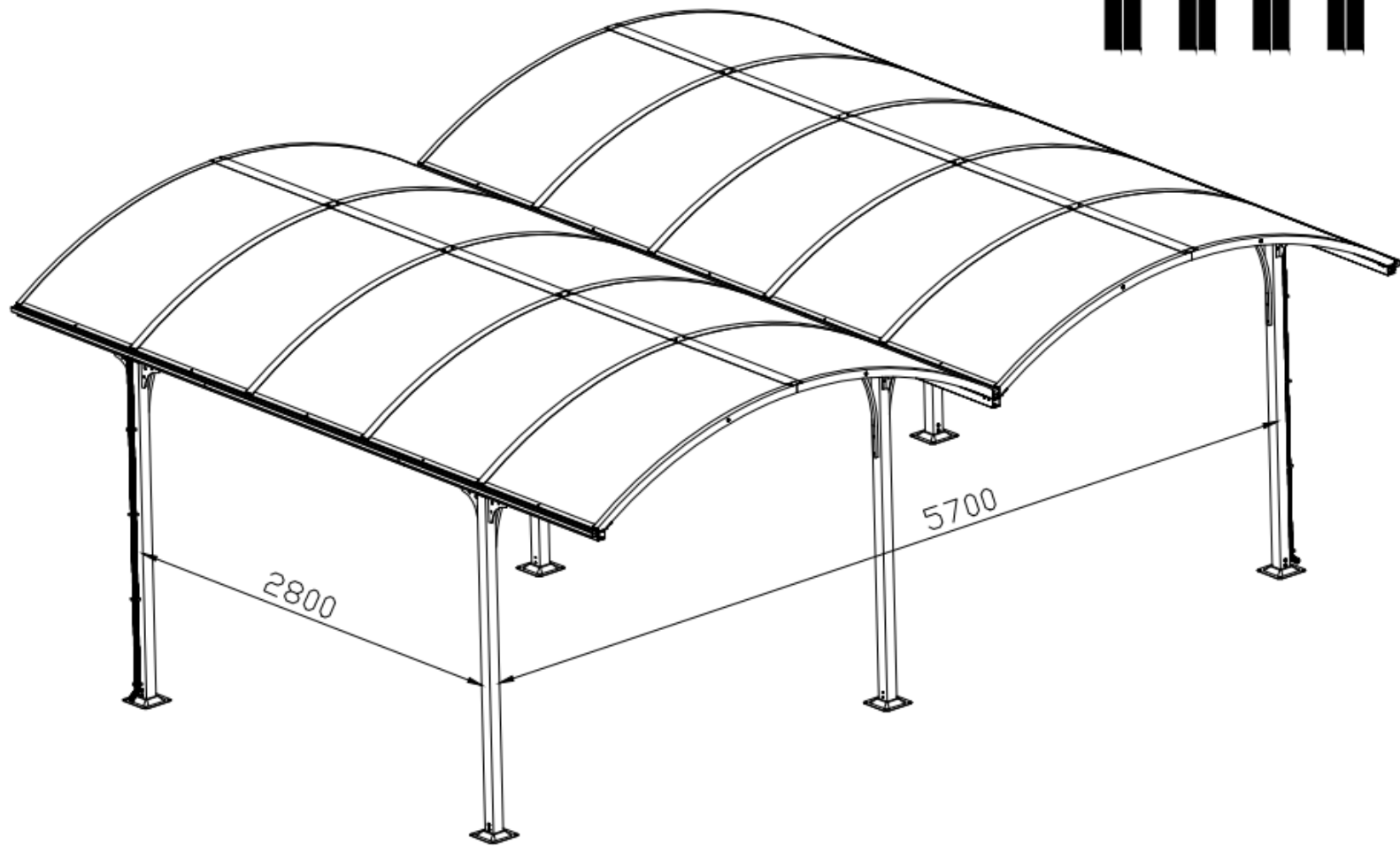



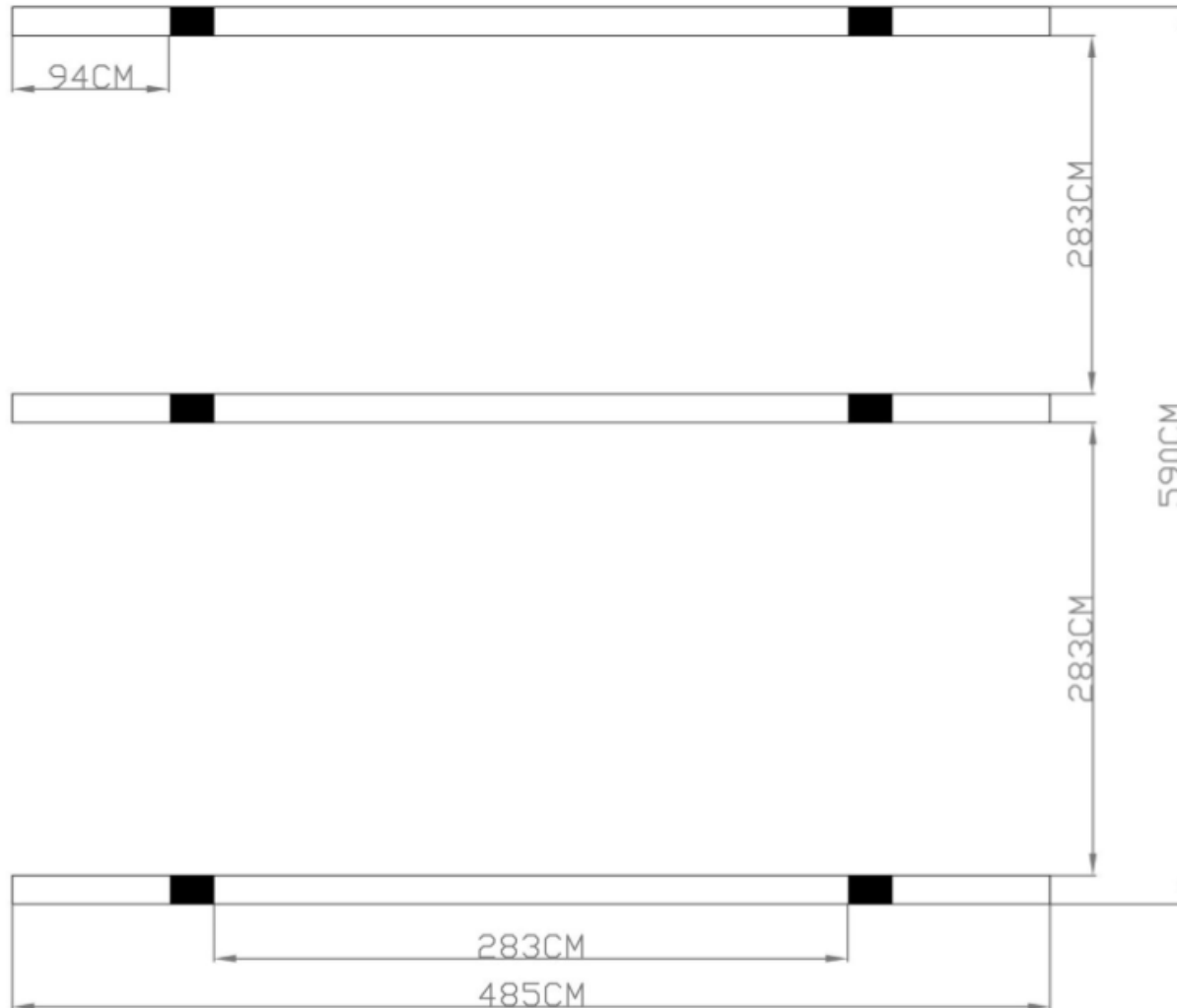













































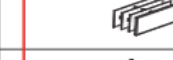









- En cas d'une pluie importante, il peut arriver que le carport laisse échapper de l'eau des gouttières latérales ou de la gouttière centrale.
- Le fabricant ne peut être tenu pour responsable de cet état de fait et des dégâts engendrés chez son propriétaire ou à l'extérieur de la propriété de celui-ci.

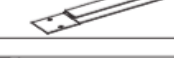
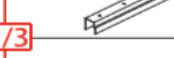





























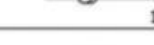













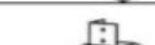
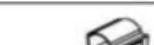





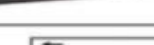











Plan de soubassement



Emplacement des pièces dans les cartons

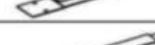

#	 MM	×	#	 MM	×	#	 MM	×	#	 MM	×
1A	 1550mm	4x	13	 1614mm	2x	29		2x	45	 1/4"x38mm	24x
1B	 1550mm	4x	14	 1614mm	2x	30		2x	46	 1/4"x70mm	11x
2A	 1550mm	2x	15	 1614mm	2x	31		4x	47	 1/4"x57mm	16x
2B	 1550mm	2x	16	 1614mm	1x	32		2x	48	 1/4"x10mm	36x
3A	 1502mm	4x	17	 1614mm	1x	33		4x	49	 1/4", 1/4"x5/16"	1x
3B	 1502mm	4x	18	 1614mm	1x	34		2x	50	 50x50	6x
4A	 1502mm	2x	19	 1614mm	1x	35		6x	51		4x
4B	 1502mm	2x	20	 1614mm	2x	36		12x	52		2x
5	 1614mm	2x	21N	 6X1550X950mm	10x	37	 1/4"x15mm	144x	53		4x
6	 1614mm	2x	22N	 6X1490X950mm	10x	38	 ø7x19x1.6mm	325x	54		2x
7	 1614mm	2x	23	 947mm	20x	39	 1/4"x15mm	94x	55	 20x20	16x
8	 905mm	20x	24	 1197mm	8x	40	 M4x8mm	24x	56	 1/4"x6mm	6x
9	 1002mm	4x	25		12x	41	 1/4"x80mm	4x			
10	 1020mm	6x	26		4x	42	 1/4"x35mm	16x			
11	 2035mm	4x	27		2x	43	 1/4"x6mm	166x			
12	 1982mm	2x	28		8x	44	 5/16"x76mm	24x			

Les pièces pour l'assemblage

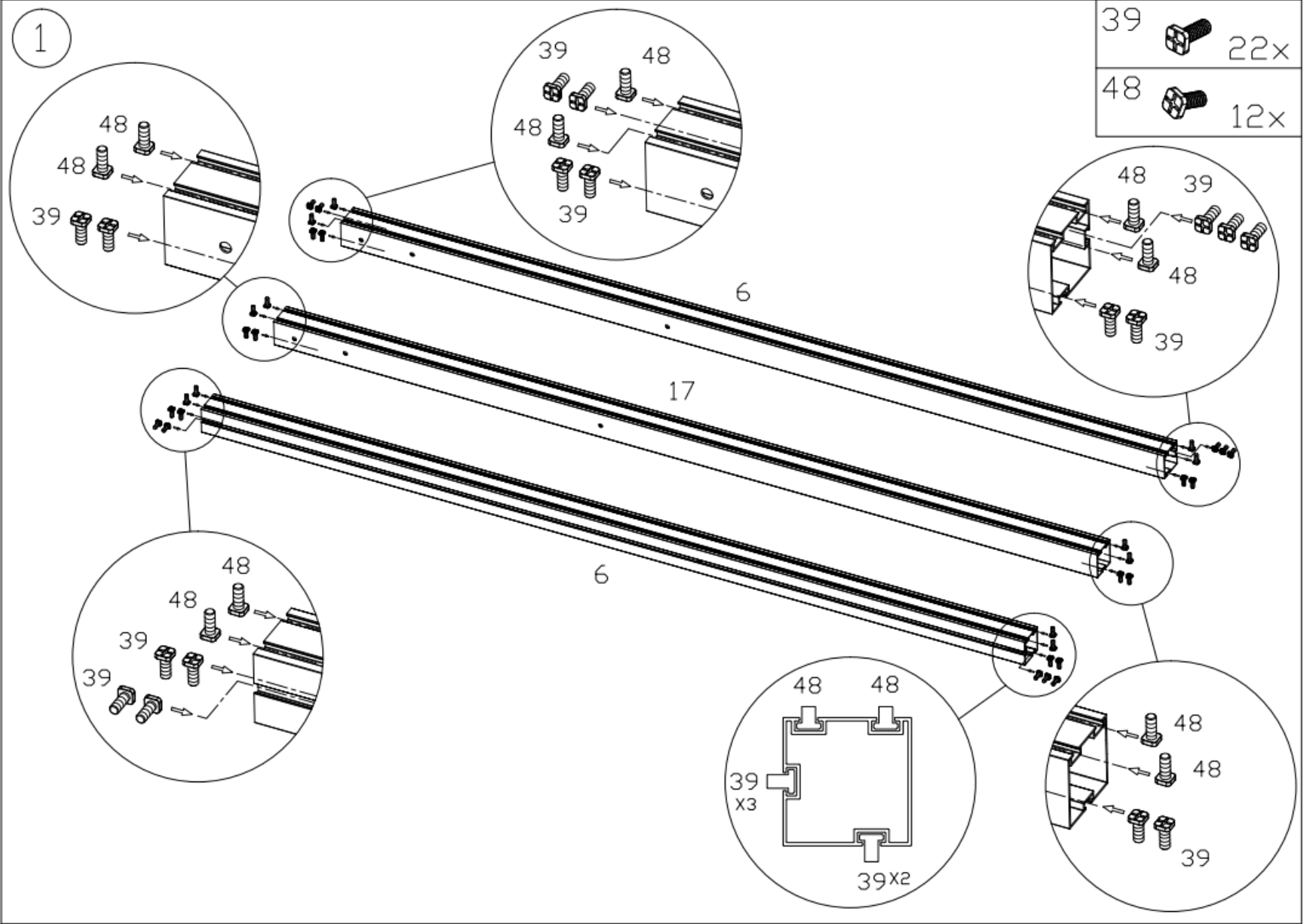
#	 MM	x	#	 MM	x	#	 MM	x	#	 MM	x
1A	 1550mm	4x	13	 1614mm	2x	29		2x	45	 1/4"x38mm	24x
1B	 1550mm	4x	14	 1614mm	2x	30		2x	46	 1/4"x70mm	11x
2A	 1550mm	2x	15	 1614mm	2x	31		4x	47	 1/4"x57mm	16x
2B	 1550mm	2x	16	 1614mm	1x	32		2x	48	 1/4"x10mm	36x
3A	 1502mm	4x	17	 1614mm	1x	33		4x	49	 1/4", 1/4", 5/16"	1x
3B	 1502mm	4x	18	 1614mm	1x	34		2x	50	 50x50	6x
4A	 1502mm	2x	19	 1614mm	1x	35		6x	51		4x
4B	 1502mm	2x	20	 1614mm	2x	36		12x	52		2x
5	 1614mm	2x	21N	 6X1550X950mm	10x	37	 1/4"x15mm	144x	53		4x
6	 1614mm	2x	22N	 6X1490X950mm	10x	38	 #7x19x1.6mm	325x	54		2x
7	 1614mm	2x	23	 947mm	20x	39	 1/4"x15mm	94x	55	 20x20	16x
8	 905mm	20x	24	 1197mm	8x	40	 M4x8mm	24x	56	 1/4"x6mm	6x
9	 1002mm	4x	25		12x	41	 1/4"x75mm	4x			
10	 1020mm	6x	26		4x	42	 1/4"x35mm	16x			
11	 2035mm	4x	27		2x	43	 1/4"x6mm	166x			
12	 1982mm	2x	28		8x	44	 5/16"x76mm	24x			



2

37		24x
38		24x

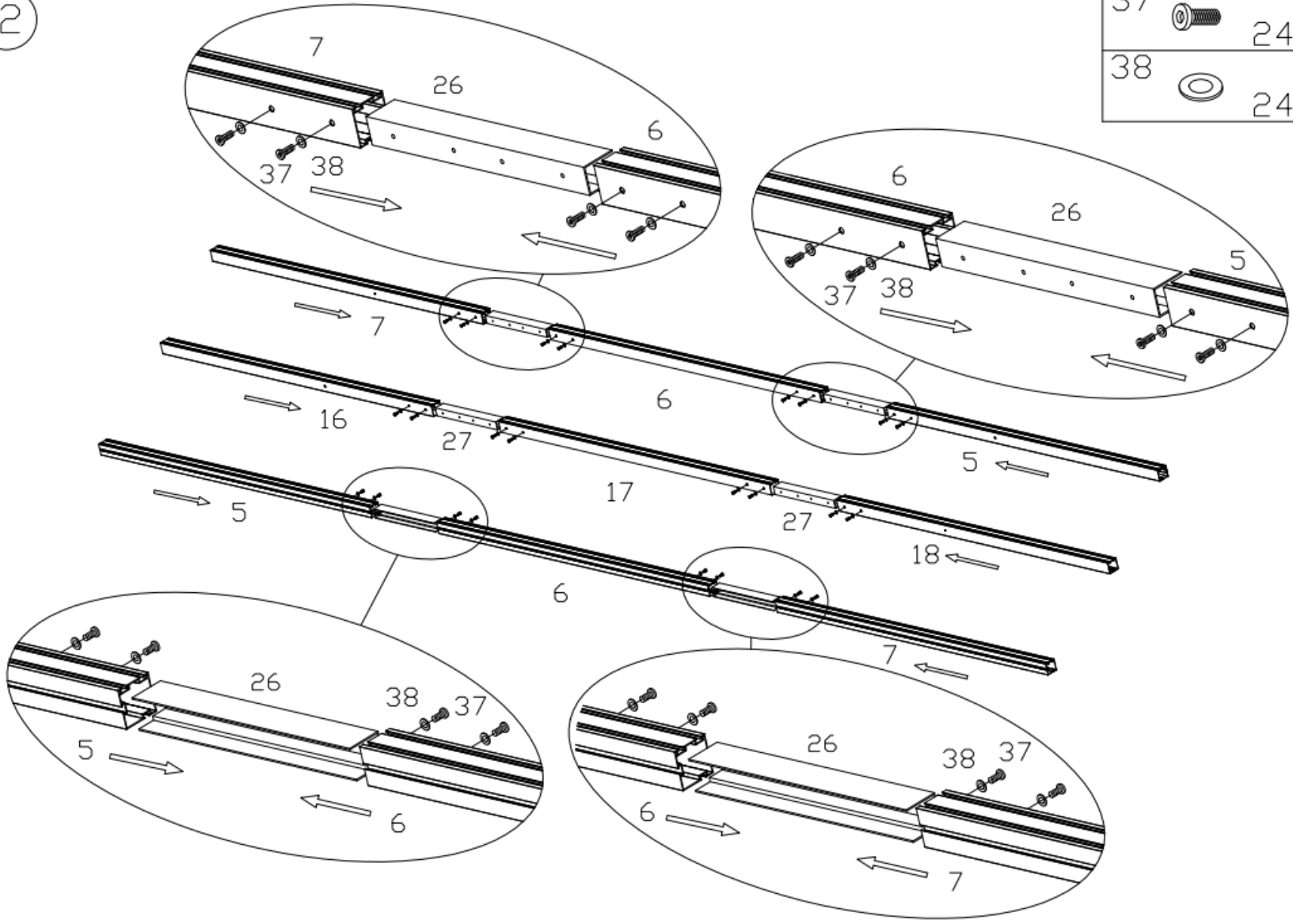

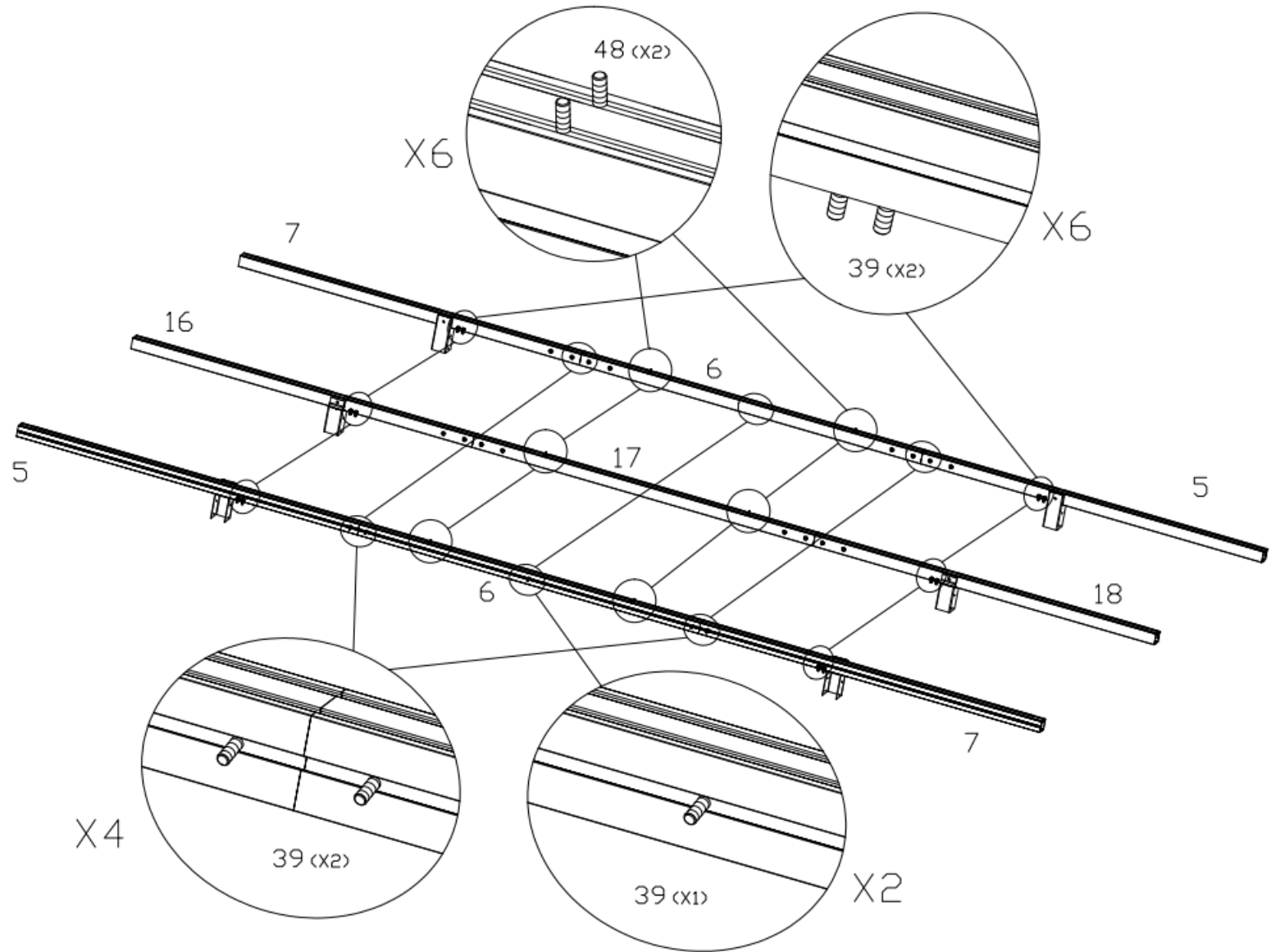

3

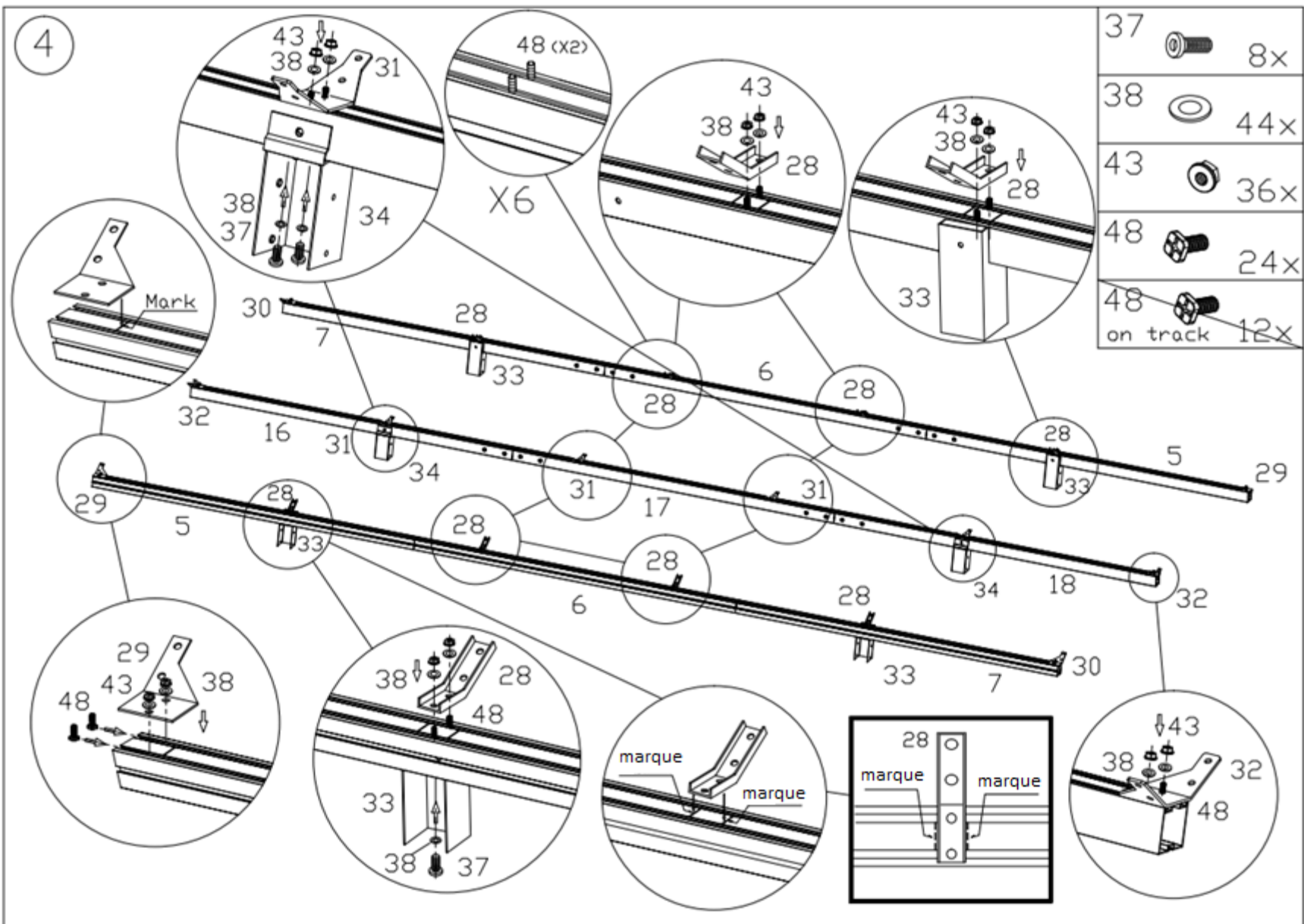



5

38		9x
46		9x

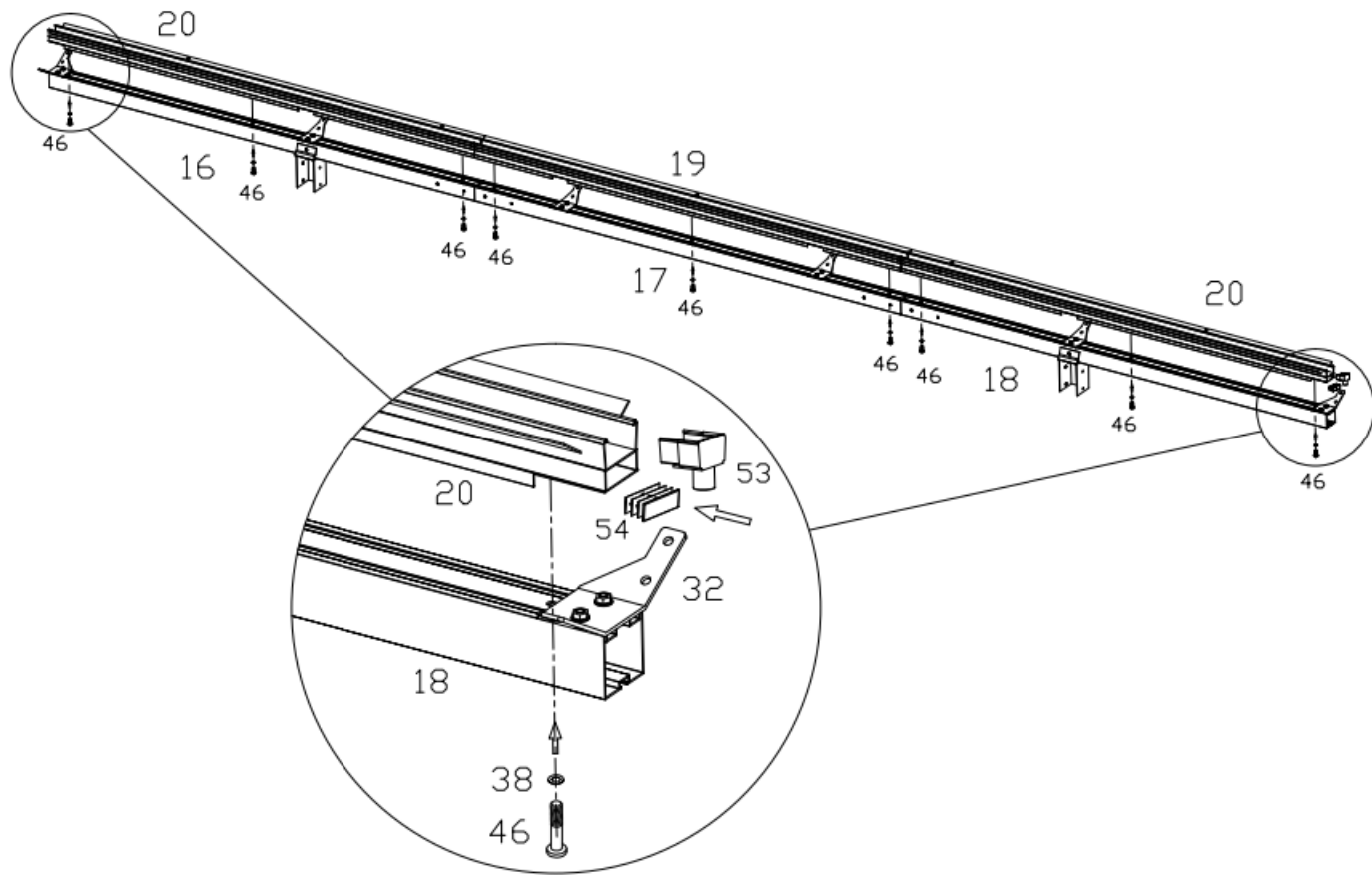



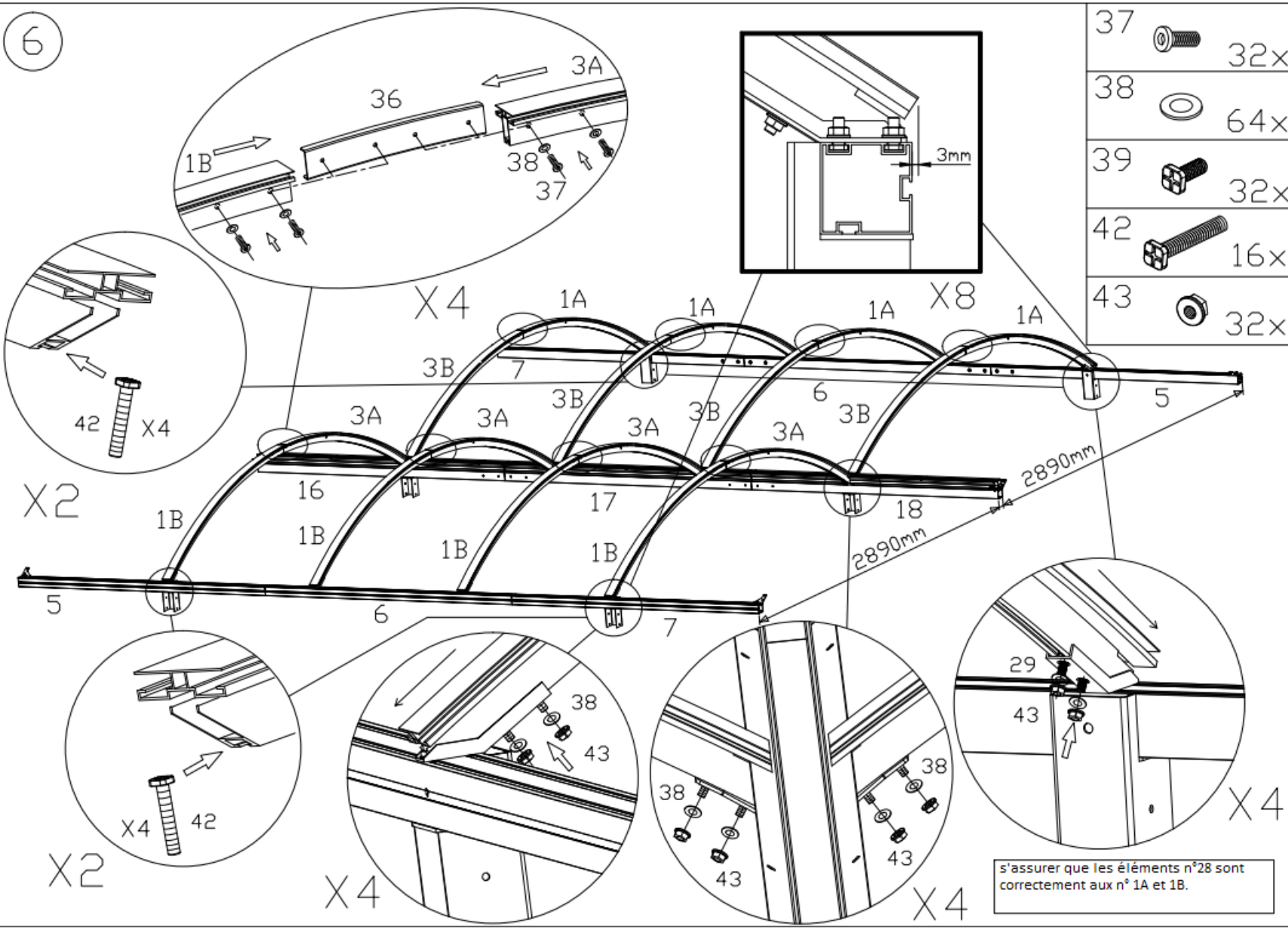

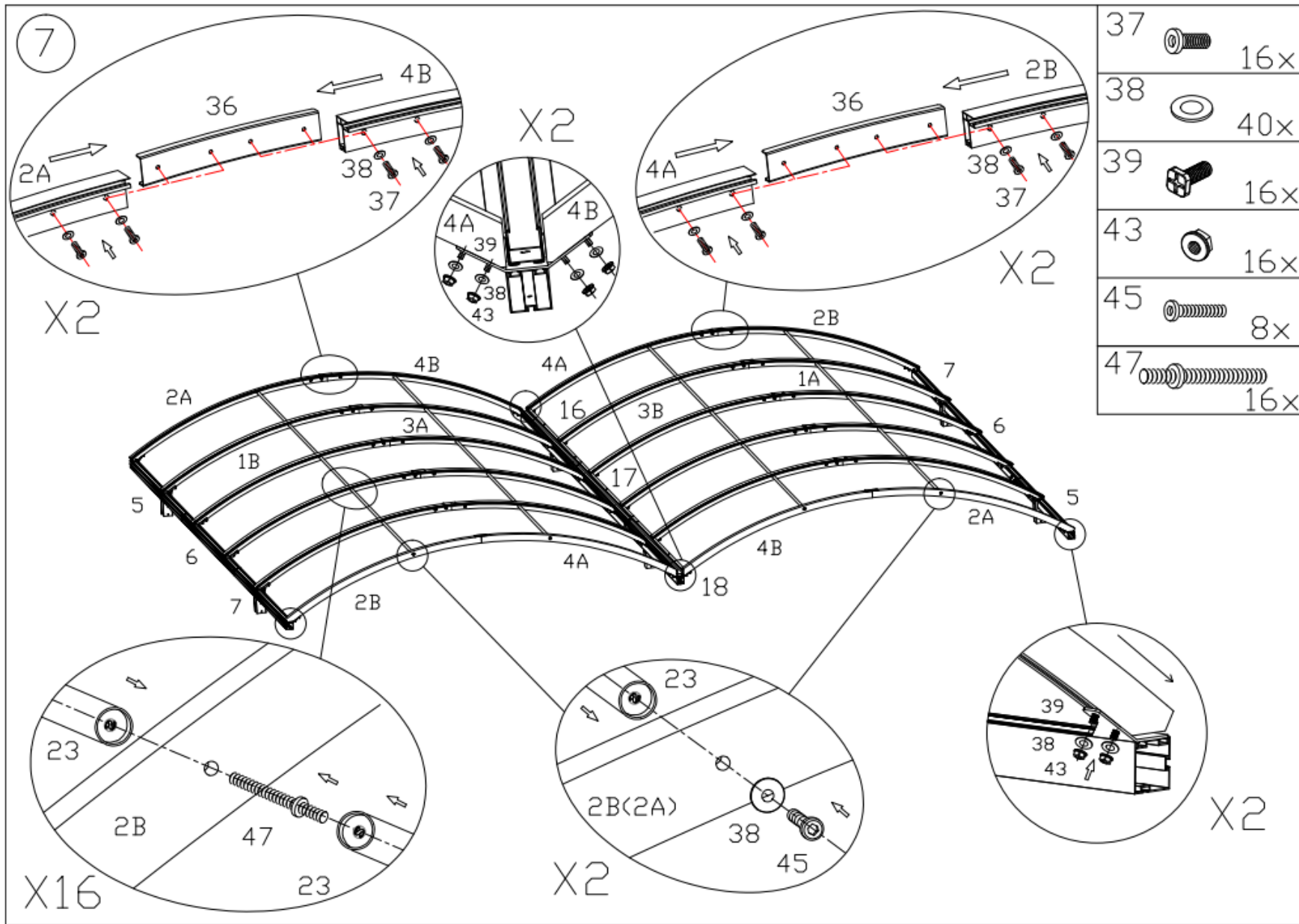

6

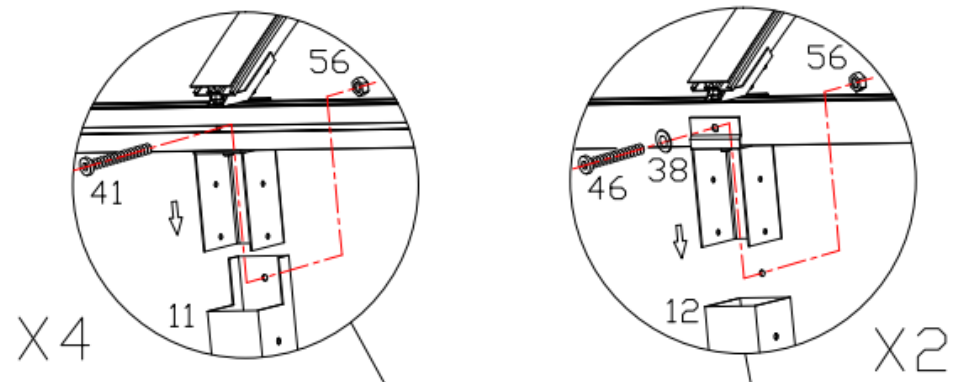



8





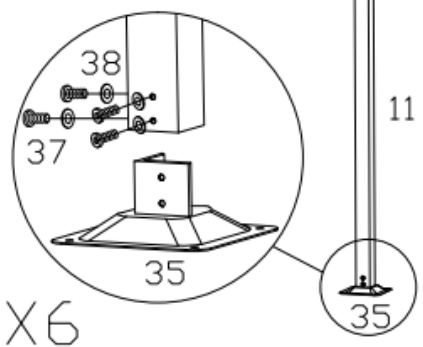
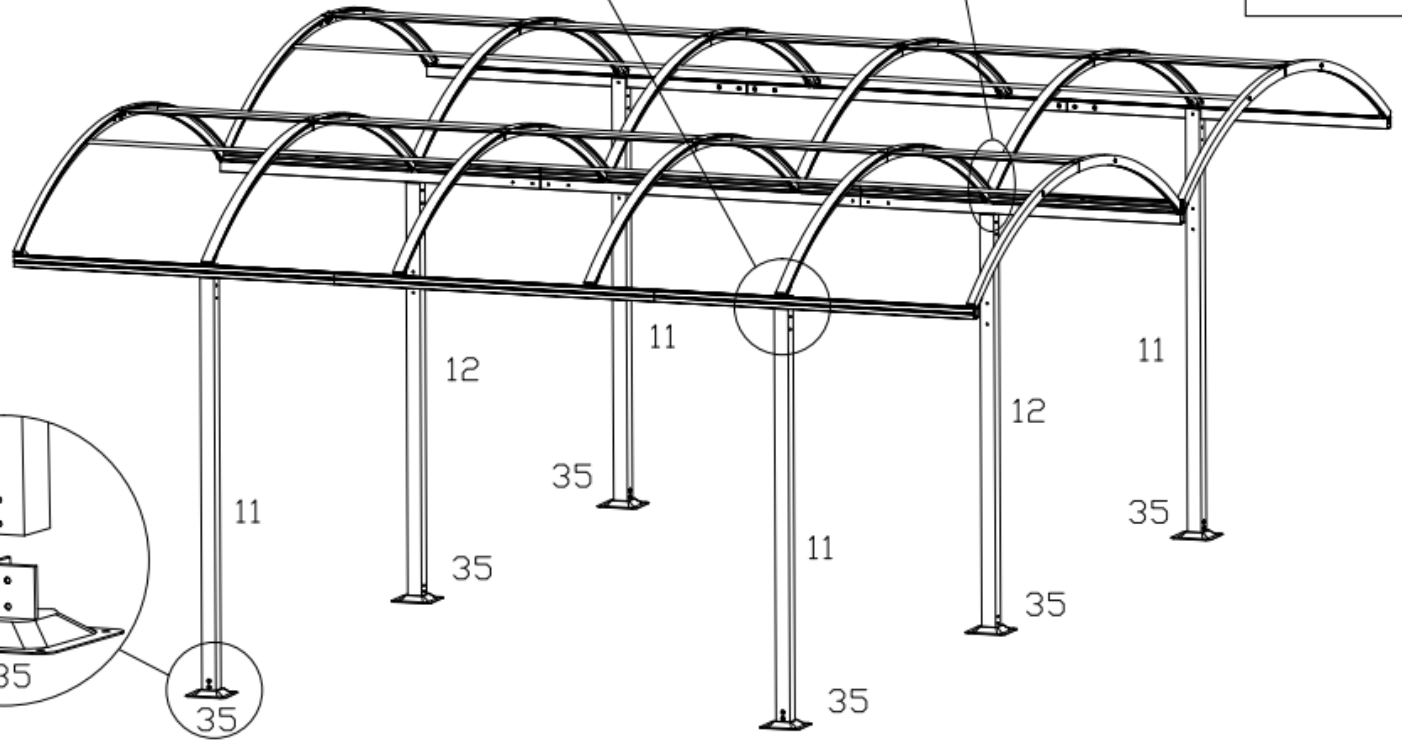



37		24x
38		26x
41		4x
46		2x
56		6x

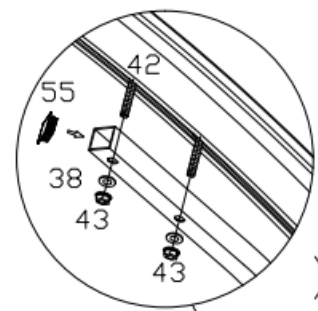
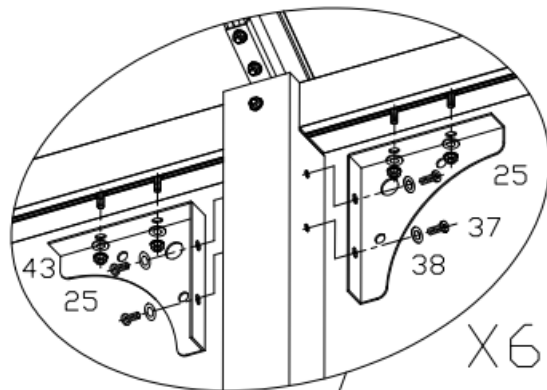

X6

9



37		24x
38		80x
39		12x
43		40x
45		16x

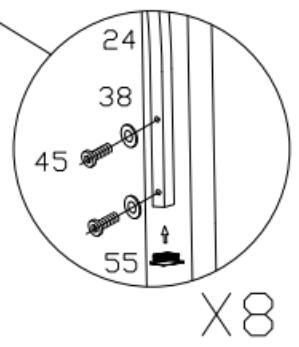
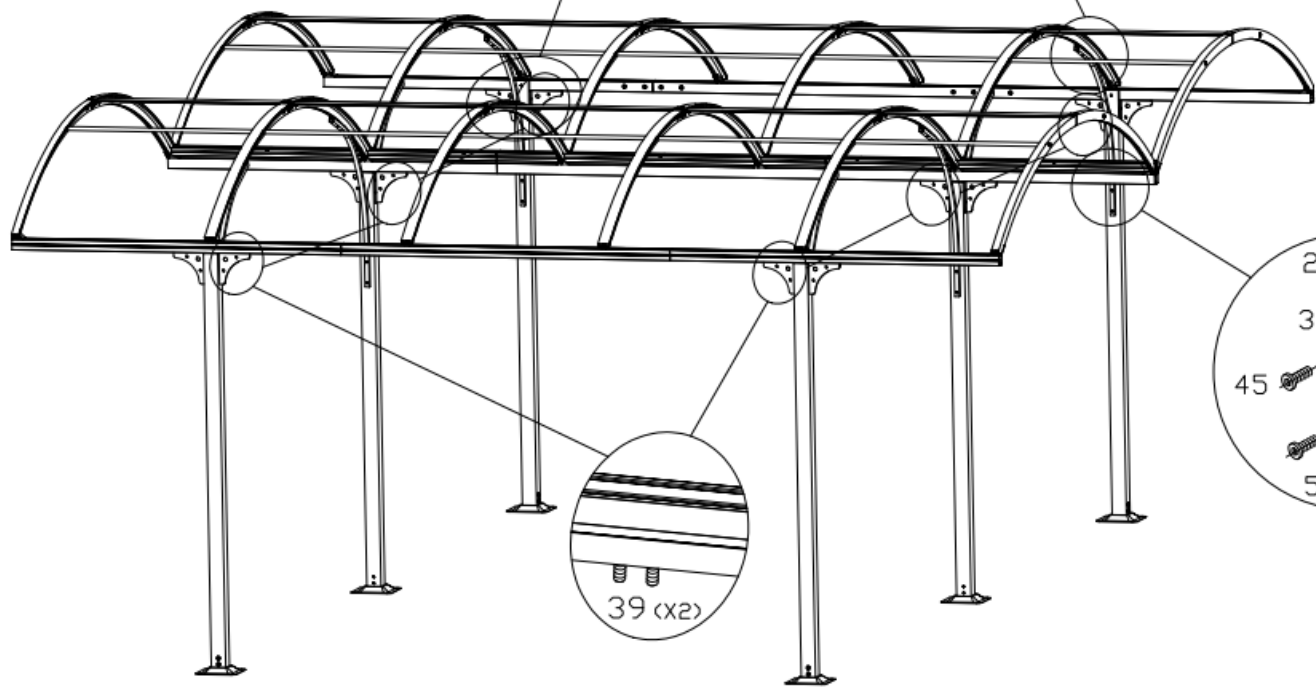

10



x10

22N

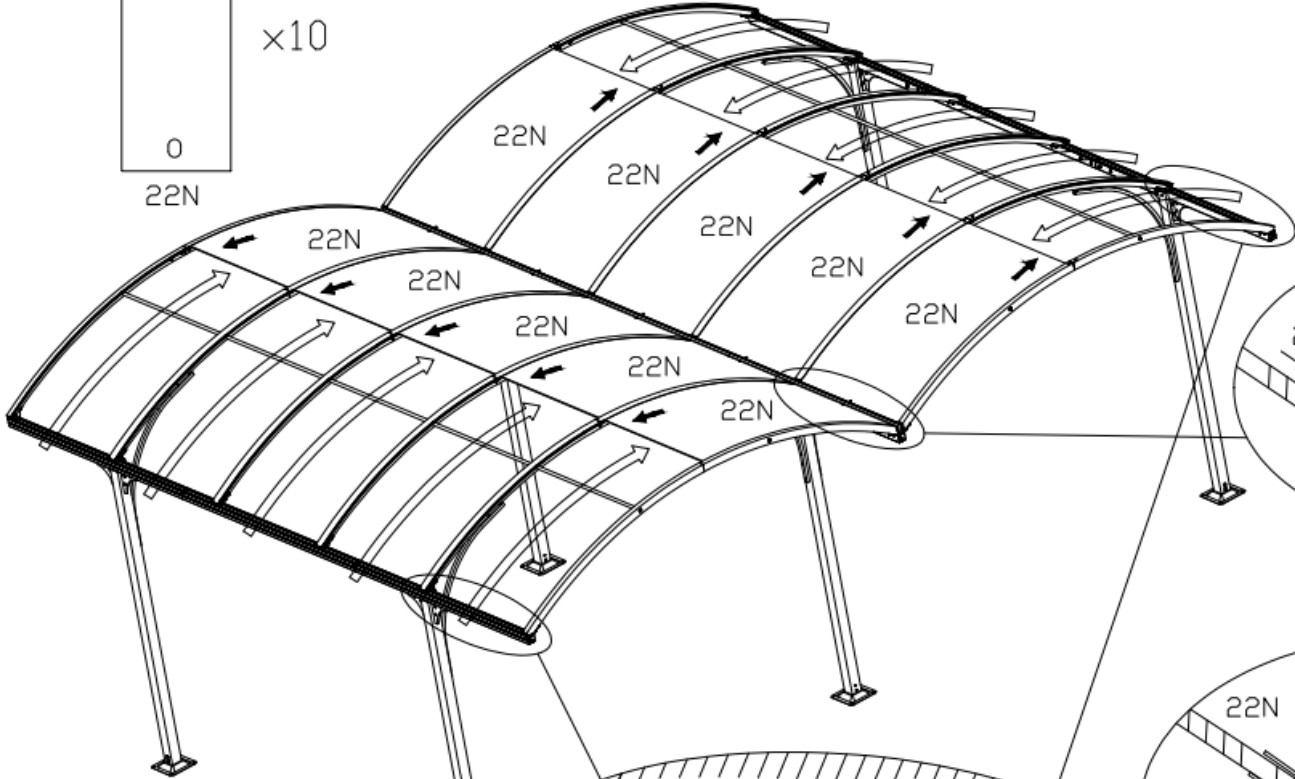

37



10x

38



10x

43



10x

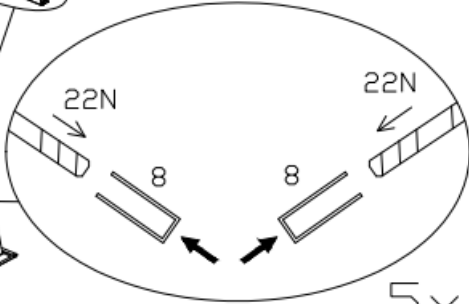

5x

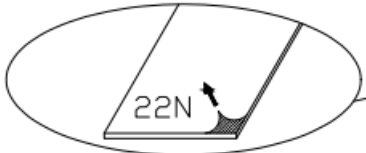
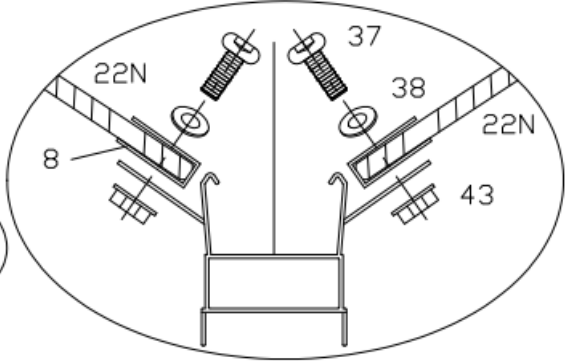

10x

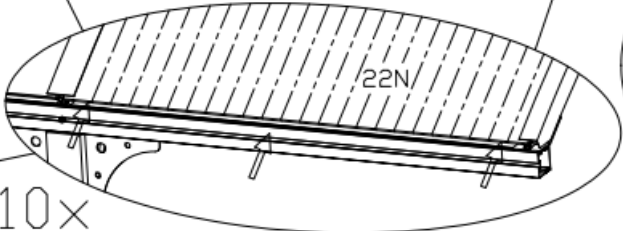

11

40  24x

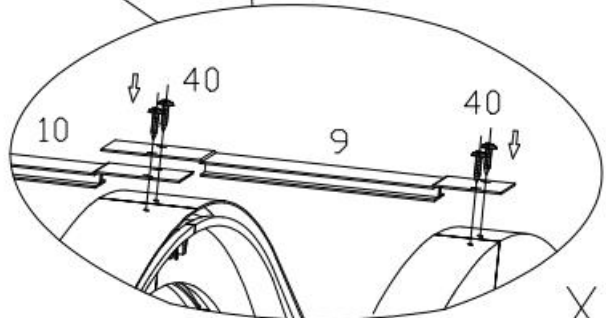
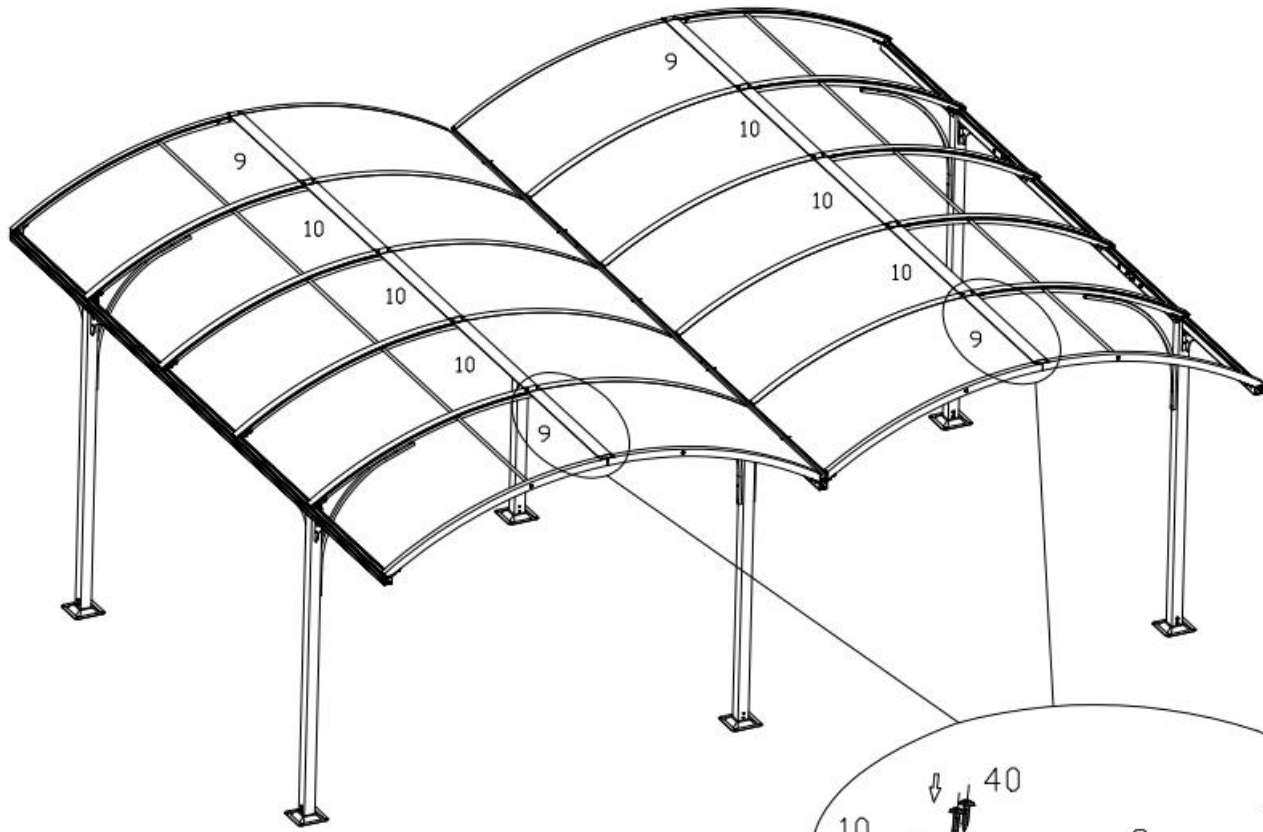

X2

12





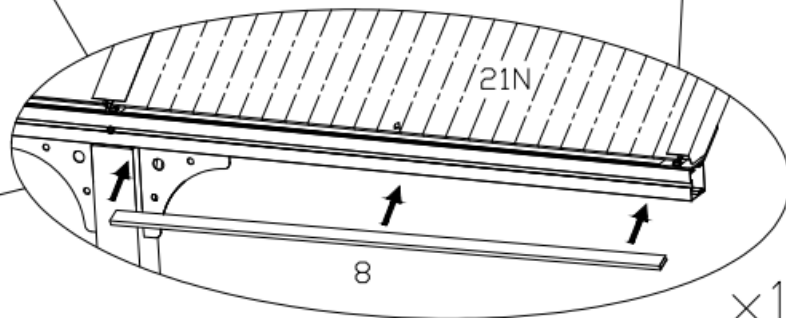
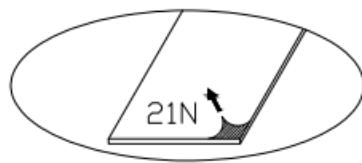
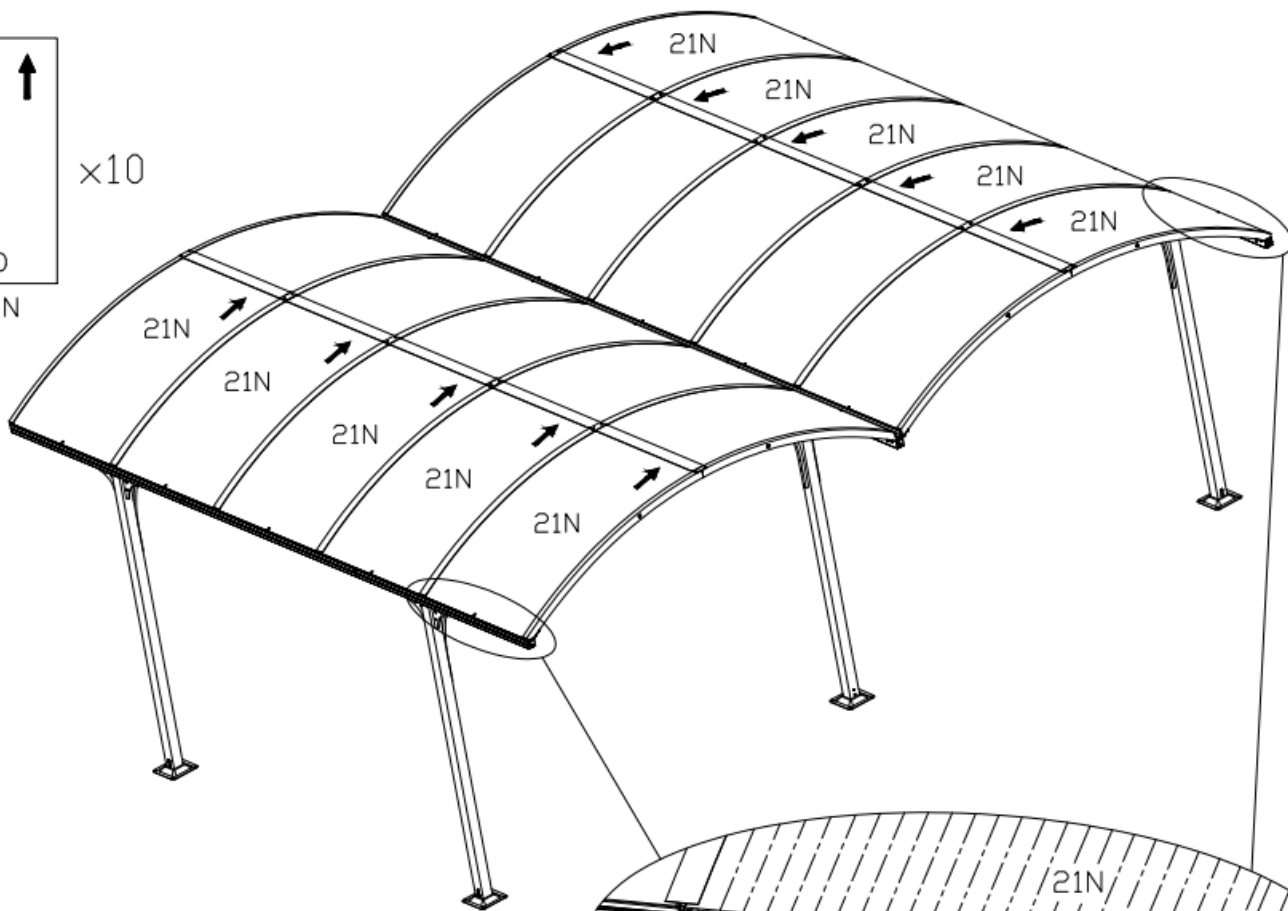

×10



×10

13

37		10x
38		28x
39		8x
43		28x

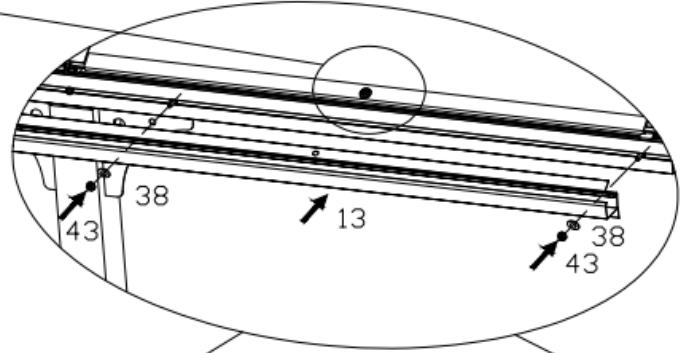
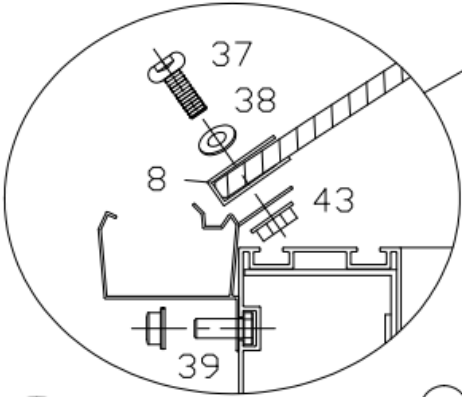

X2

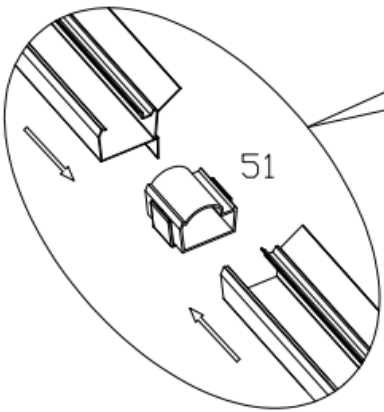
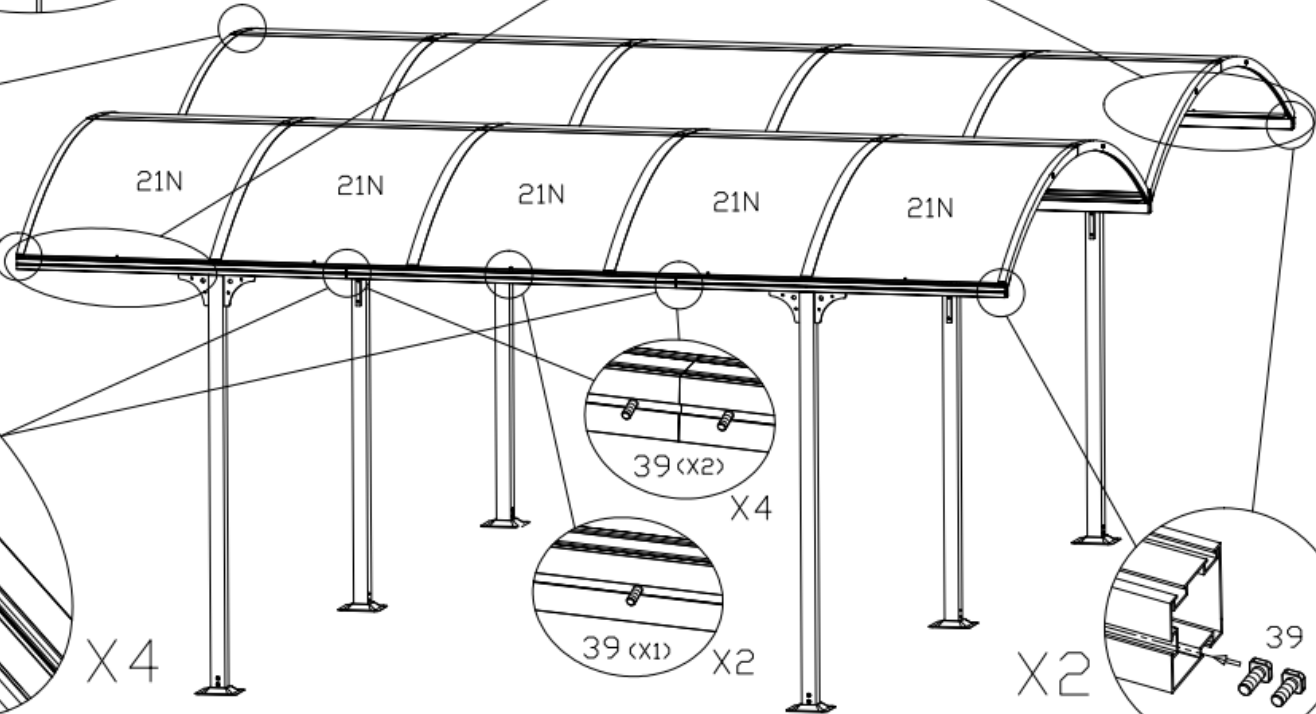
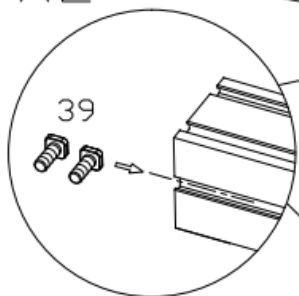

X4

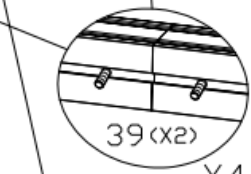

39 (x2)

X4

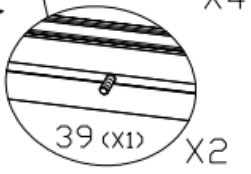

39 (x1)

X2

X2

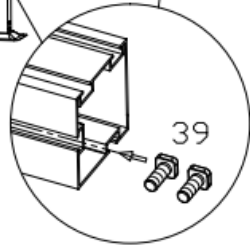

39

14

44 24x

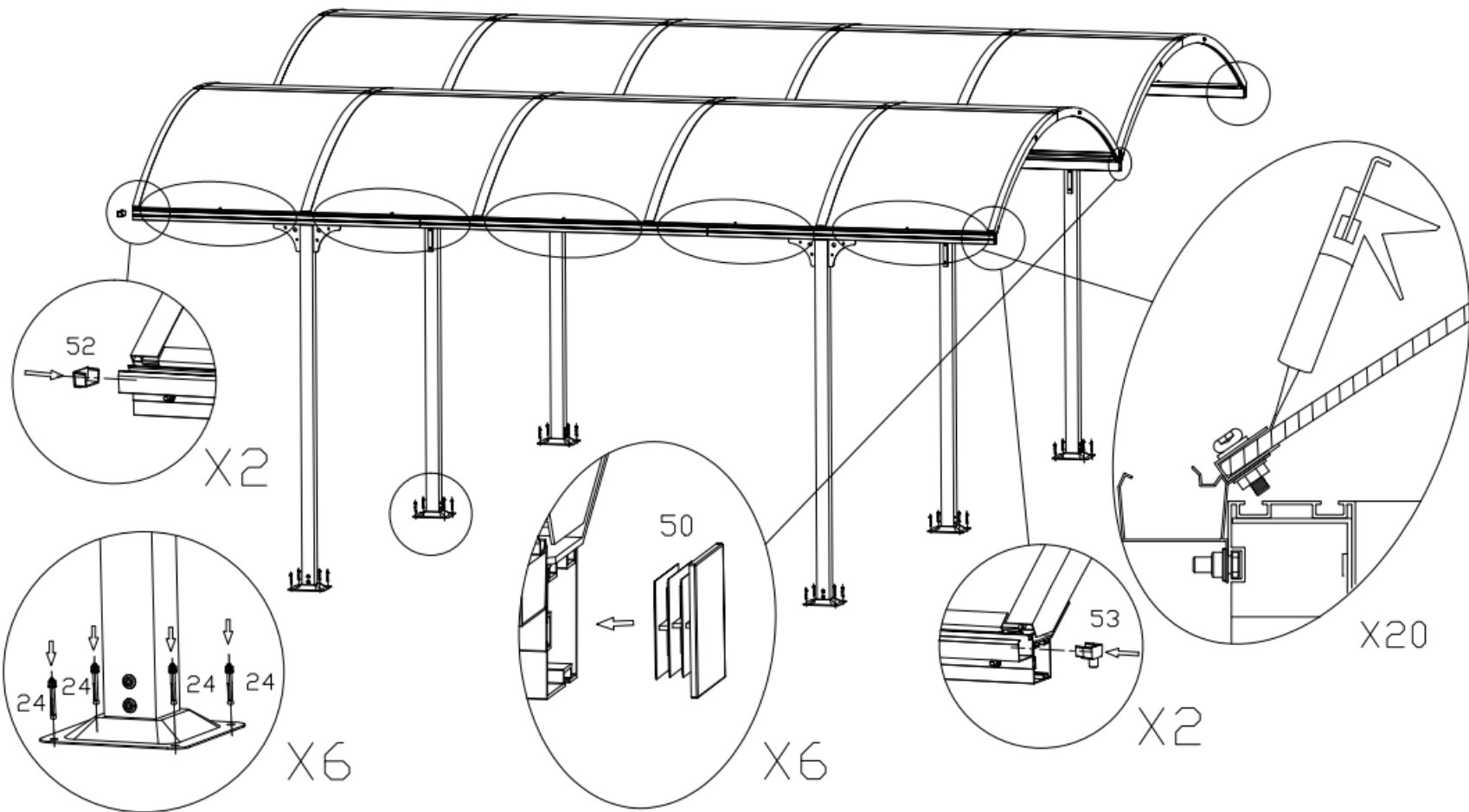

Pour maximiser l'étanchéité des gouttières, appliquer un mastic d'étanchéité d'extérieur (non fourni) à toutes les pièces en contact.

IMPORTANT

Le fabricant décline toute responsabilité dans les dégâts éventuels causés par le non-respect des instructions de l'installation du présent document, décline toute responsabilité en cas de modification arbitraire des pièces d'origine. La corrosion des pièces métalliques : sur votre carport certaines pièces de jonction ou de fixation au sol peuvent être en acier. Nous vous recommandons, en cas de brouillard salin ou d'air chargé de sel, d'entretenir les pièces sur votre carport. Le produit n'est pas garanti contre la corrosion due au vent salin.

CONSIGNES D'ENTRETIEN

- Nettoyer à l'eau claire ou avec des produits au PH neutre,
- Déblayer les feuilles qui peuvent obstruer le toit et la gouttière d'évacuation .

