

EN

REPLACING PLATES KIT

OLTRE

fapim[®]



ULIB - Rev.00

8169A

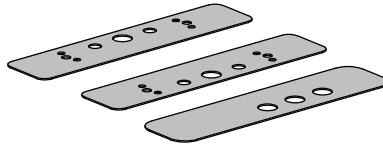

OLTRE BAR



8269A

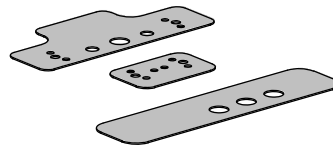

OLTRE PUSH

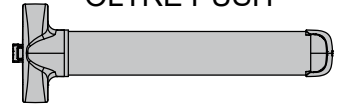

8469A

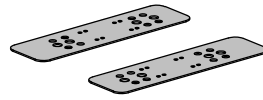

8416

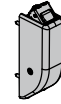

8436

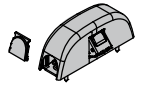

8169A

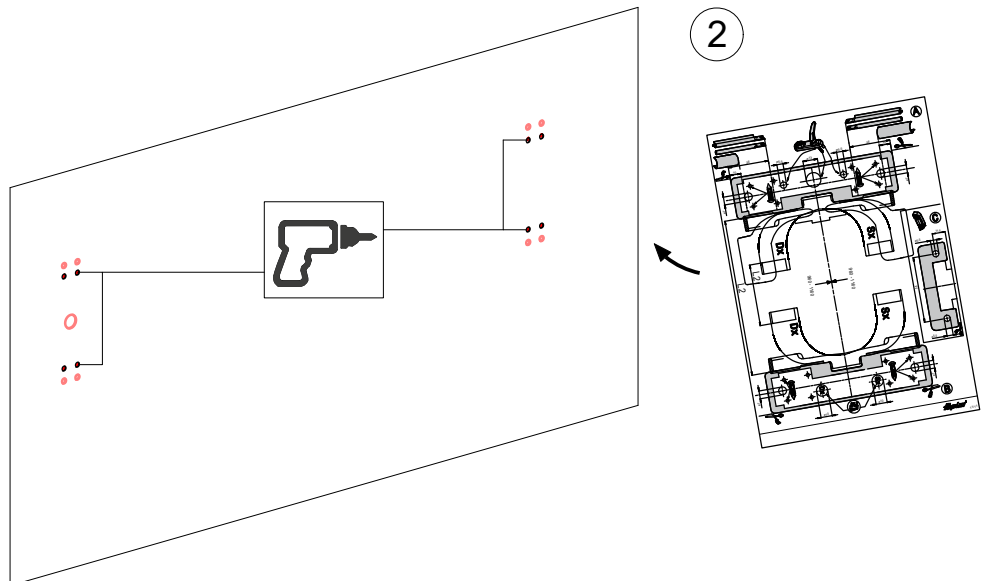
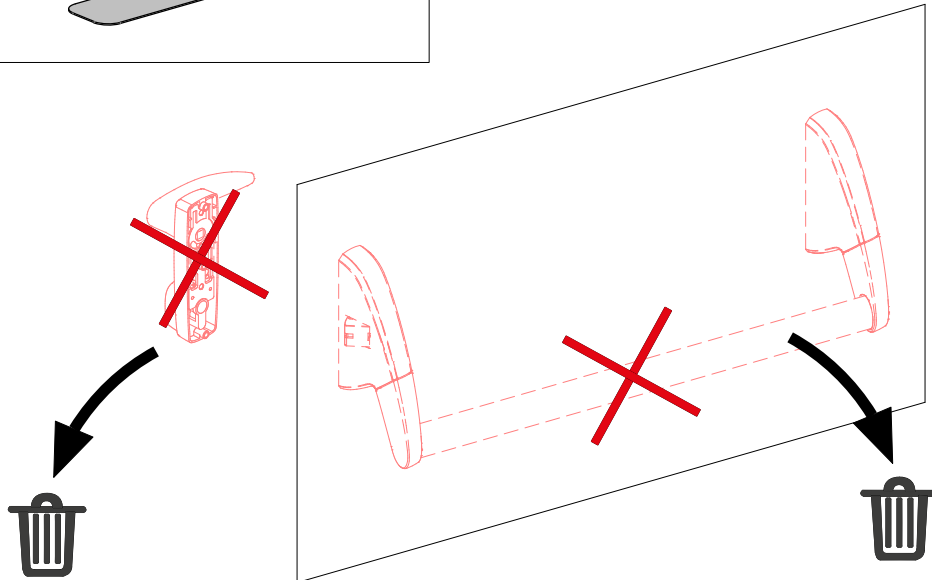
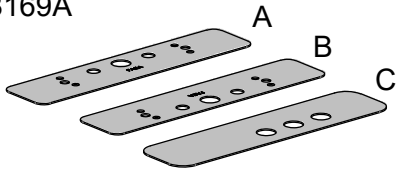

fapim[®]

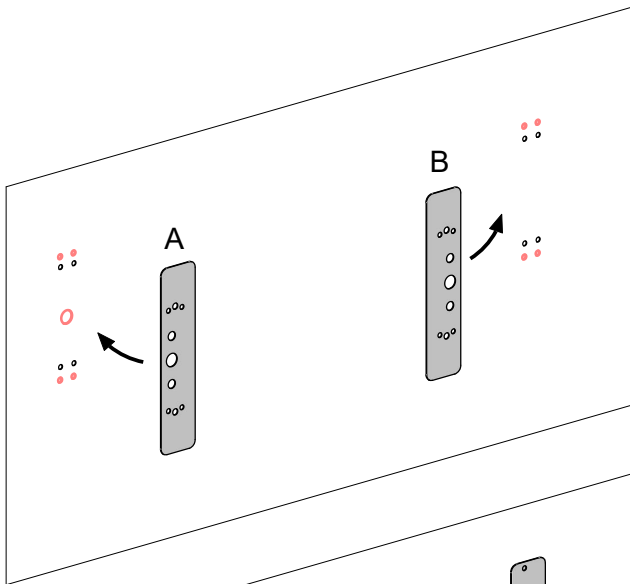

3

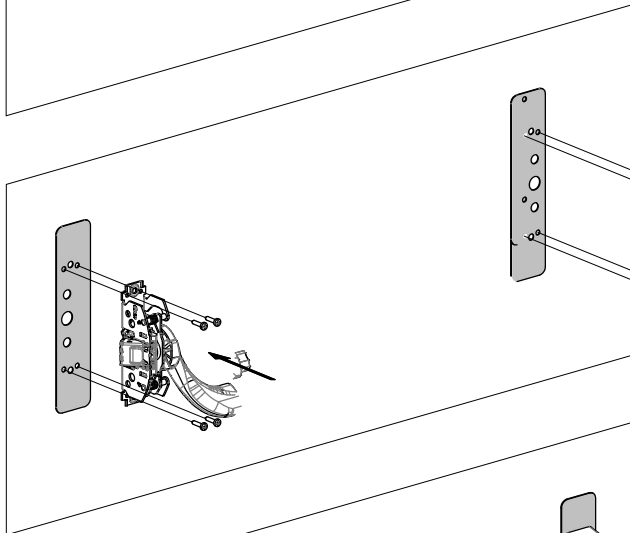

4

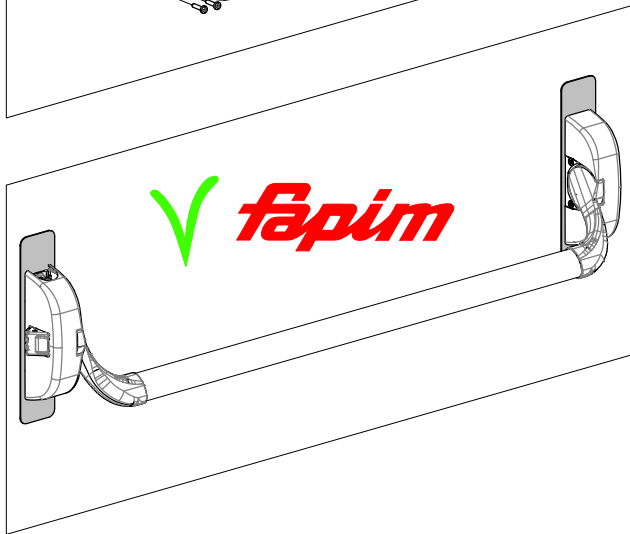

5



+1 mm

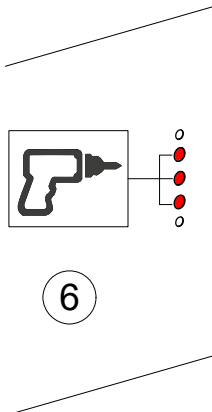
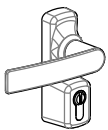
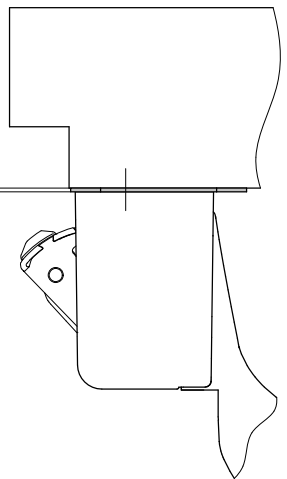

6

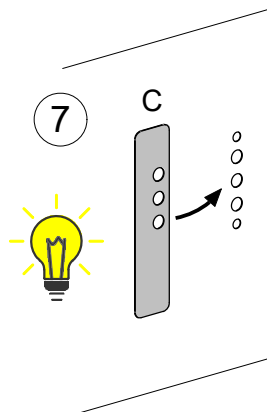

7

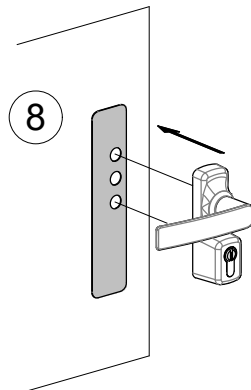

8

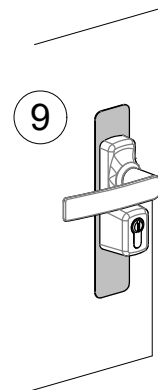

9



fapim

8269A

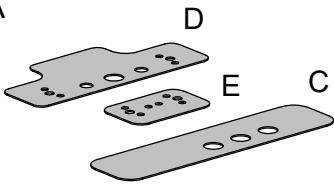

1

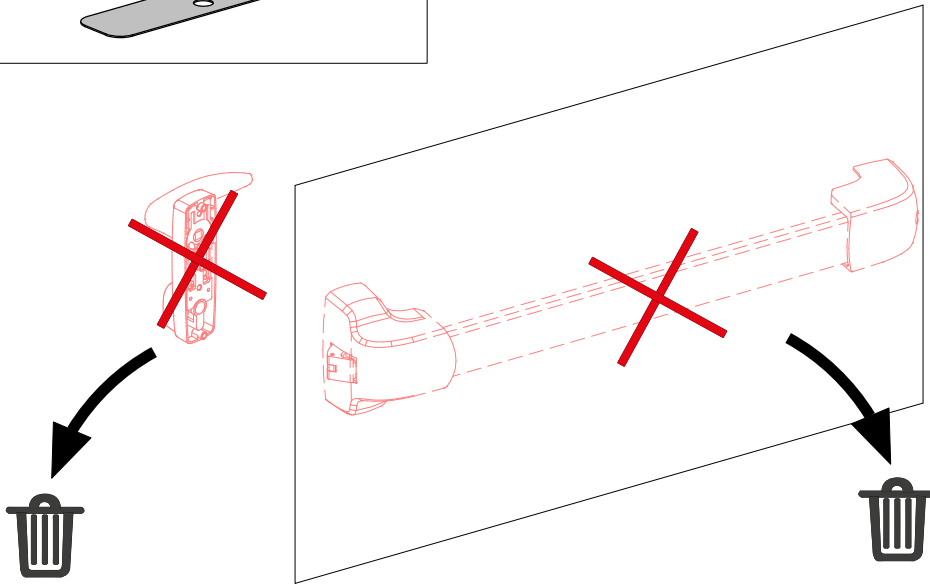

2

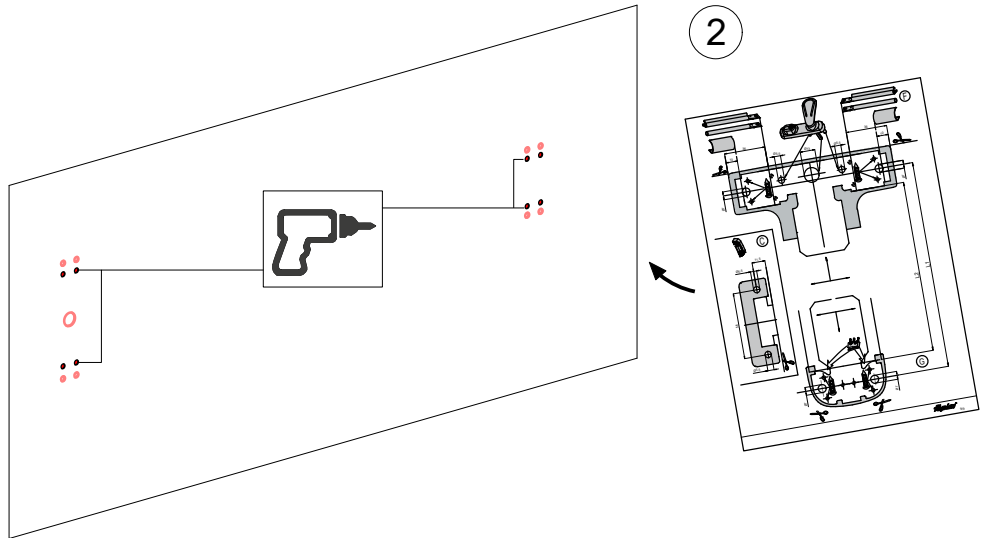

3

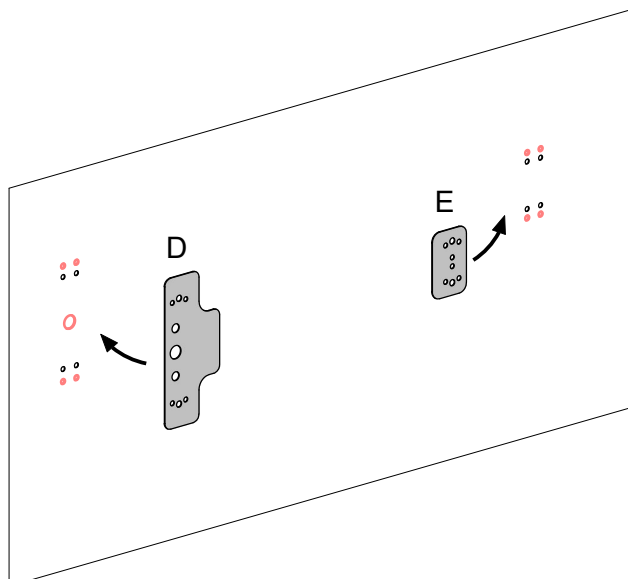

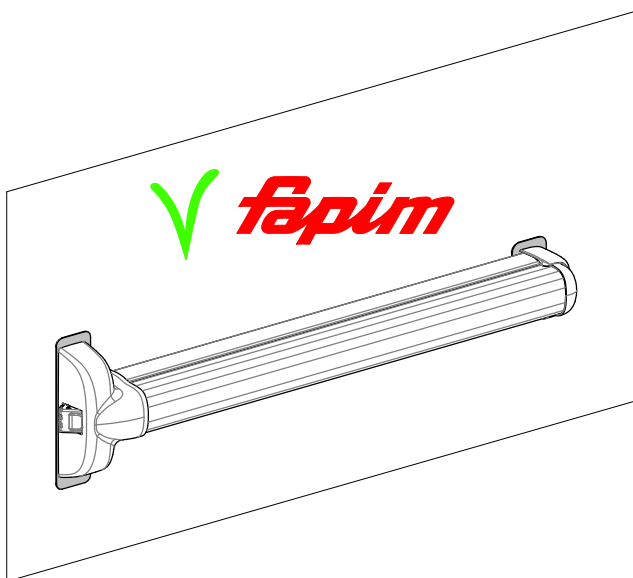
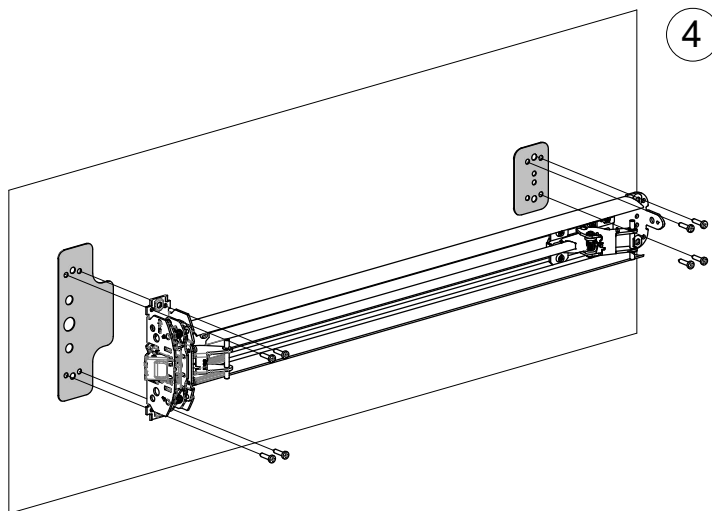

5



+1 mm

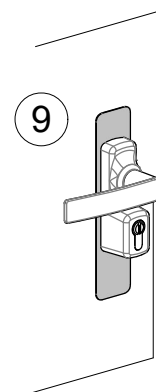
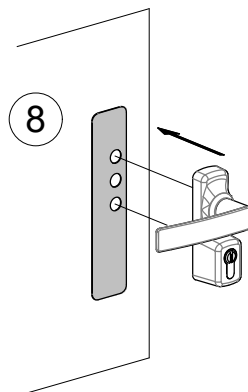
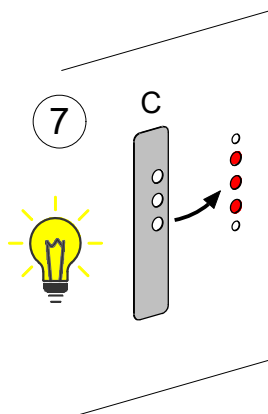
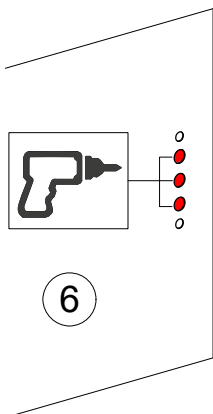
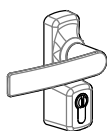
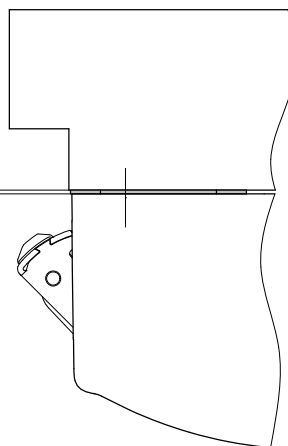

8469A

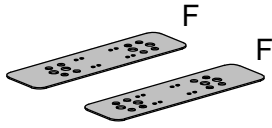

1

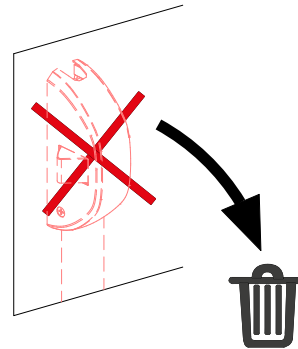
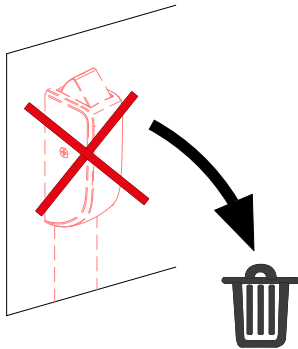

2

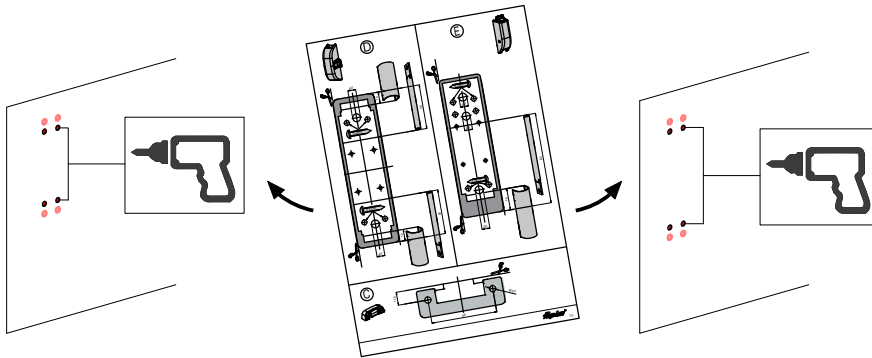

3



4

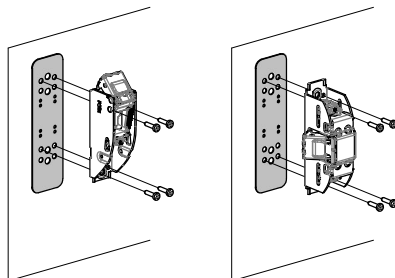

5

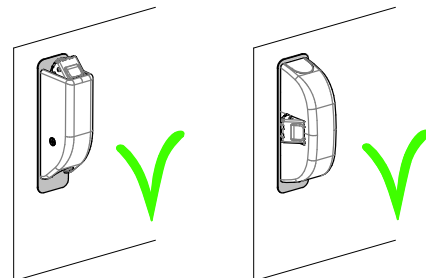

fapim