

FAR TOOLS®

- FR** Ponceuse surfaceuse de sol (Notice originale)
- EN** resurfacing floor sander (Original manual translation)
- DE** Scheuermaschine mit langer stange (Übersetzung aus der Originalanleitung)
- ES** Lijadora de repavimentación de pisos (Traducción del manual de instrucciones originale)
- IT** Levigatrice per pavimenti (Traduzione dell'avvertenza originale)
- PT** recapeamento lixadeira chão (Tradução do livro de instruções original)
- NL** Schuurmachine voor vloervernieuwing (Vertaling van de originele instructies)
- EL** Τριβείο επιφανειών δαπέδου (Πρωτότυπες οδηγίες)
- PL** Nawierzchni podłogi Sander (Tłumaczenie z oryginalnej instrukcji)
- FI** Betonhiomakone (Käännös alkuperäisestä ohjeet)
- SV** Betongslip (Översättning från originalinstruktioner)
- BG** Sander етаж пилинг (Превод на оригиналната инструкция)
- DA** Betonslibemaskine (Oversættelse fra oprindelige brugsanvisning)
- RO** Sander etaj resurfacing (Traducere din instrucțiunile originale)
- RU** Sander пол шлифовка (Перевод с оригинальной инструкции)
- TR** Sander zemin yenileme (Orijinal talimatlar çeviri)
- CS** Sander patro resurfacing (Překlad z originálního návodu)
- SK** Sander poschodie resurfacing (Překlad z originálneho návodu)
- HE** תירוּקמ הרעה) רדנס תפצר תושדחתה
- AR** (تفحص األ قطع الحبل) حلاخة بزأوية قأئمة
- HU** Sander padló pályás (Fordítás az eredeti utasítások)
- SL** Sander nadstropje preplastitvijo (Prevod iz izvornih navodil)
- ET** Sander korrusel koormine (Tõlge originaal juhiseid)
- LV** Sander grīdas seguma atjaunošanu (Tulkojumā no instrukcijas oriģinālvalodā)
- LT** Pjūklai grindų klojimas (Vertimas iš originalių instrukcijas)
- HR** Brusilica za podnu površinu (Prijevod prema originalne upute)



PSB 1300
Professional Machine



© FAR GROUP EUROPE

115190-Manual-C-20230503



fartools.com



5 min

MERCI !

**ECO
ACTION**



**100 %
RECYCLABLE**

Retravailler le conditionnement nous à permis de supprimer tous les emballages issus de produits dérivés d'hydrocarbures, au profit d'un packaging **100 % recyclable**.

>>> Pour en savoir plus, flashez ce code
et retrouvez toutes les informations sur notre site :



Description et repérage des organes de la machine
Description and location of machine parts

A

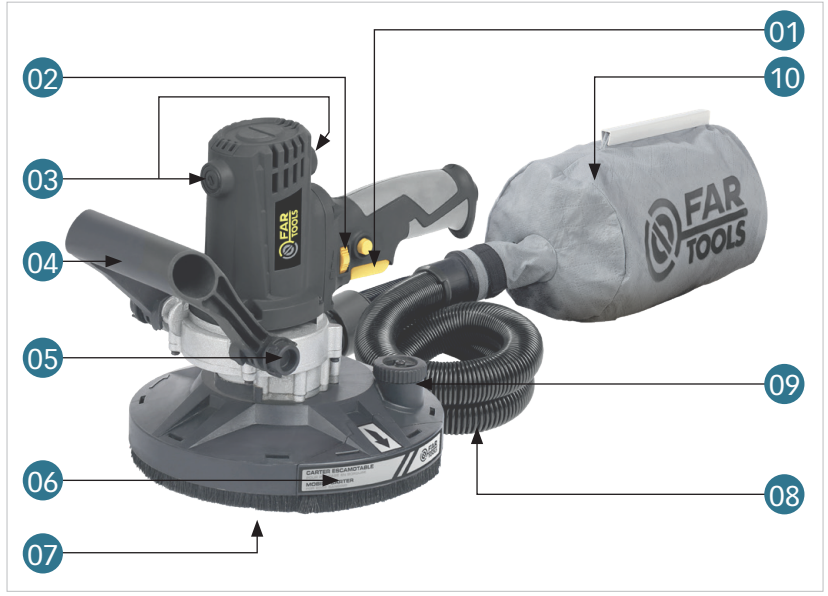

Contenu du carton
Contents of box

B

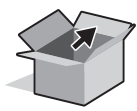

Assemblage de la machine
Assembling the machine

C

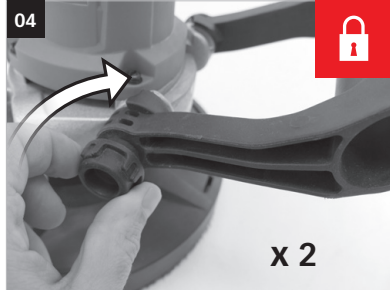
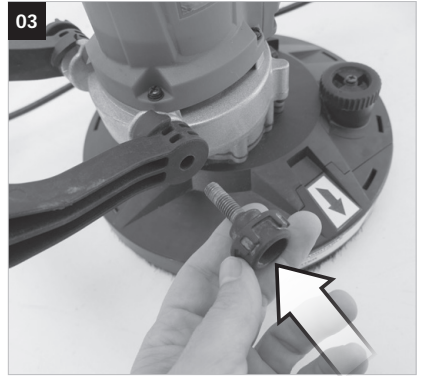
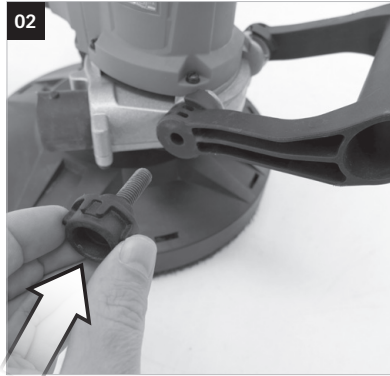
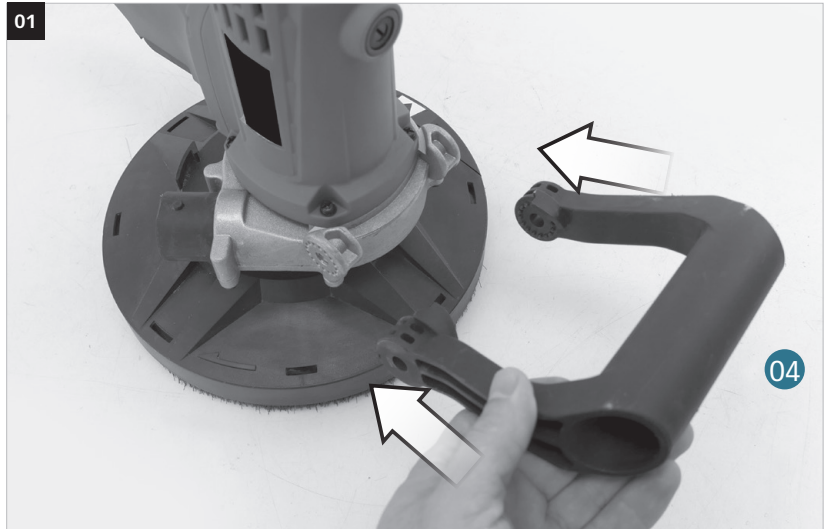

Réglages de la machine
Machine settings

D

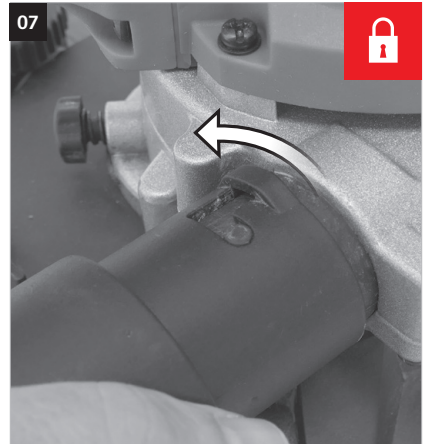
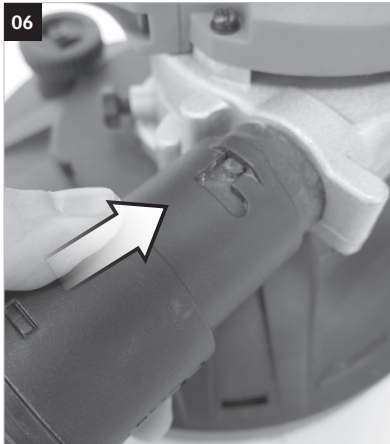
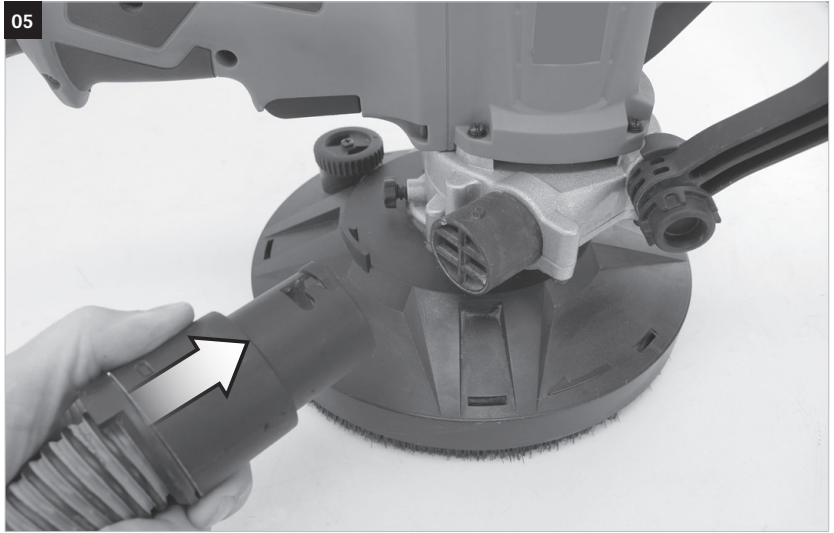

D



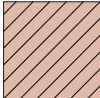

Zone non travaillée
Not Finished area

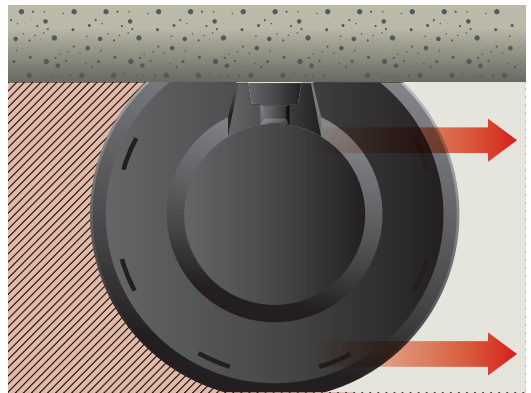
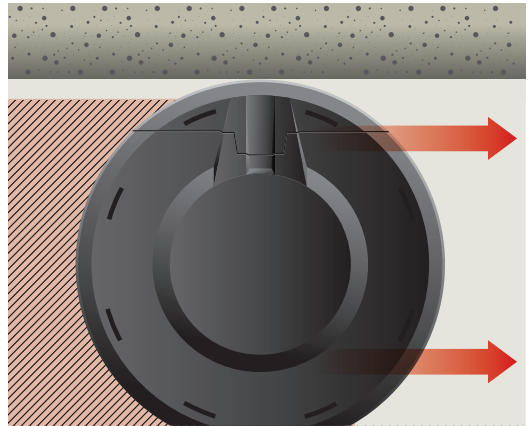
Zone travaillée
Finished area

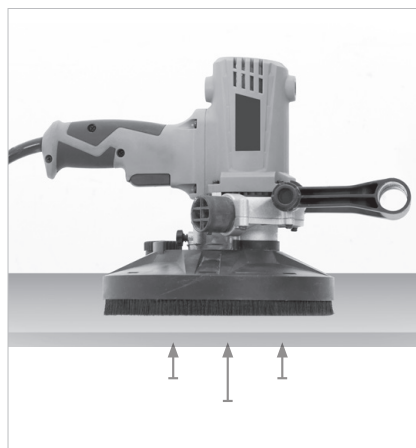
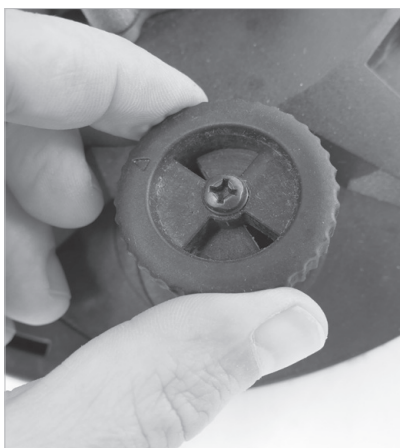
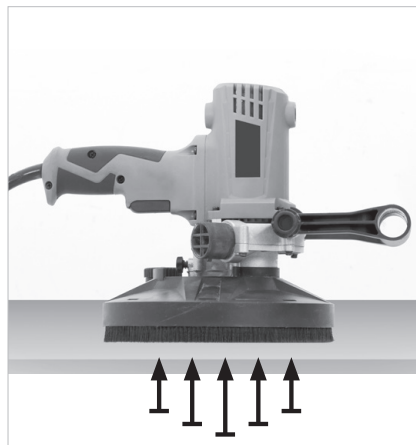
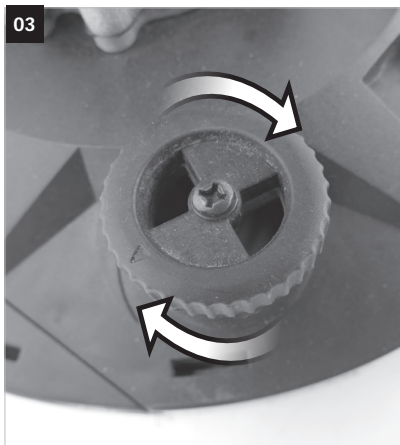

D



Remplacement des
consommables
Consumables
replacing

E



07

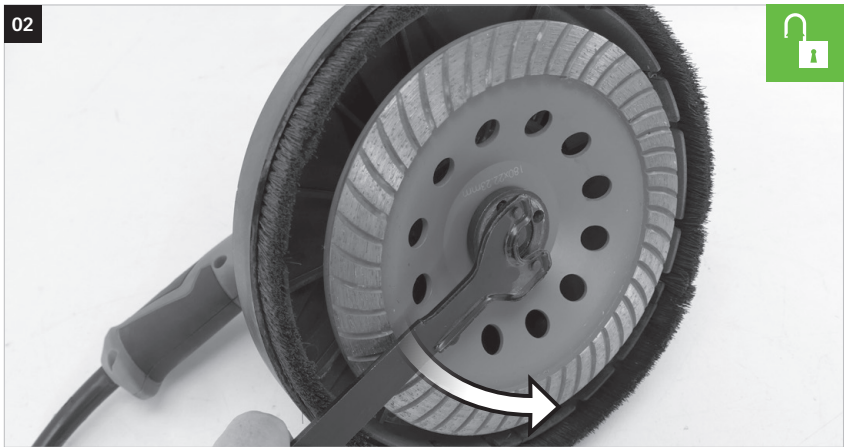
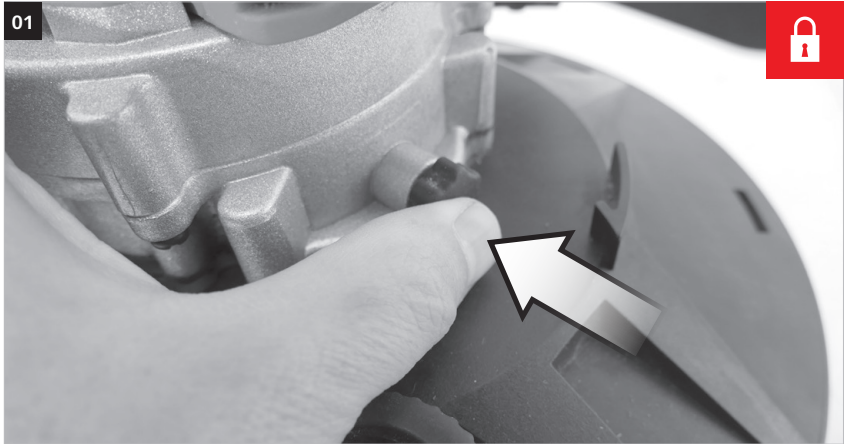



Option - Option - Option - Opcional - Opzione - Opção - Optie - Επιλογή - Opcja - Valinnainen - Tillval -
Дополнительно - Ekstra udstyr - Optiune - Опция - seçenek / seçim - Volba - Volba - הציפוי - رایج -
Opció - Možnost - Valik - Opcija - Izvele



115940 :

Disque spécial béton ø 180 mm
Speciale betonschijf ø 180 mm
Disco de hormigón especial ø 180 mm
Disco de concreto especial ø 180 mm
Disco in cemento speciale ø 180 mm
Special concrete disc ø 180 mm

Remplacement des consommables
Consumables replacing

F

01

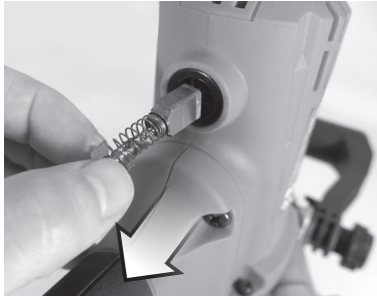
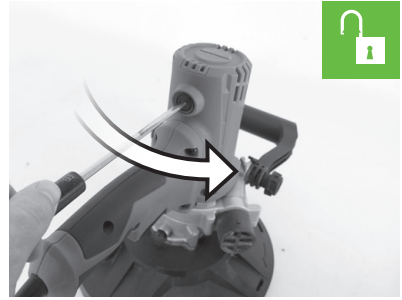
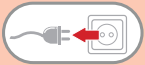

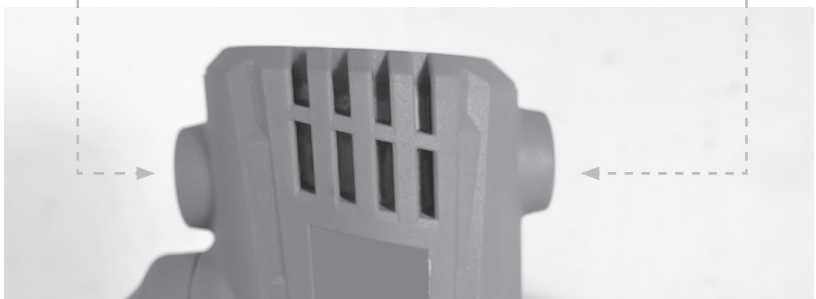
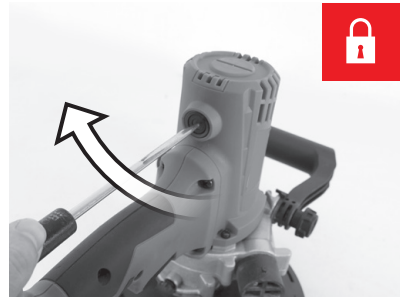

Charbons non fournis !
Koolborstels niet inbegrepen!
Escobillas de carbón no incluidas!
Escovas de carvão não incluídas!
Spazzole di carbone non incluse!
Carbon brushes not included!



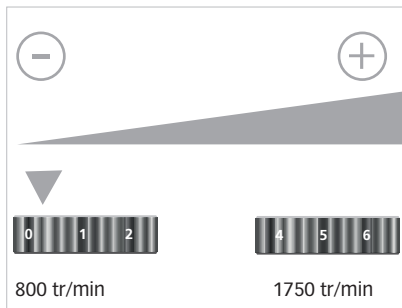
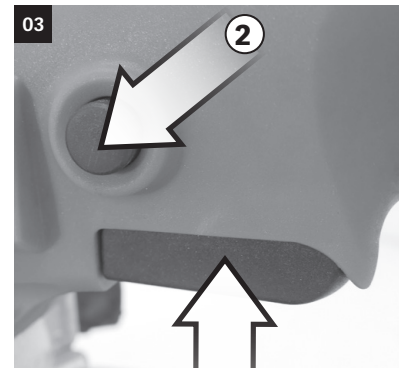
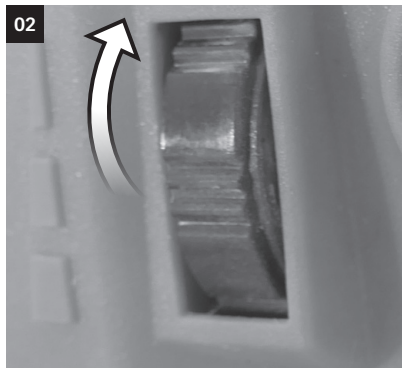
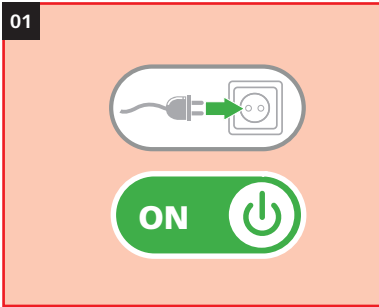

Changer les charbons des deux côtés ! - Vervang de koolborstels aan beide kanten! - ¡Cambie las escobillas de carbón de ambos lados! - Troque as escovas de carvão dos dois lados! - Cambia le spazzole di carbone su entrambi i lati! - Change the carbons on both sides!

G





	<p>Tension et fréquence assignée: Nominal frequency and power: Nennspannung und Nennfrequenz : Tensión y frecuencia fijada: Tensione e frequenza assegnata: Tensão e frequência fixa: Aangewezen spanning en frequentie: Ονομαστική τάση και συχνότητα: Napięcie i częstotliwość przydzielona: Jännite ja määrätty taajuus: Angiven spänning och frekvens: Anført spænding og frekvens: Tensiune și frecvență de lucru:</p>	<p>Заданное напряжение и частота: Tahsis gerilimi ve frekans: Stanovené napětí a frekvence: Stanovené napätie a frekvencia: Merkespenning og merkefrekvens: الفلطية والذبذبة المبرمجة. Névléges feszültség és frekvencia: Napetost in določena frekvenca: Консумирано напрежение и честота : Määratud pinge ja sagedus Nustatyta įtampa ir dažnis Noteiktais spriegums un frekvence. Napon i nazivna frekvencija:</p>	<p>230 V ~ 50 Hz</p>
---	--	---	----------------------

	<p>Puissance assignée: Nominal power: Nennleistung: Potencia fijada: Potenza assegnata: Potência assinada: Onbelast toerental: Ονομαστική ισχύς: Prędkość na biegu jałowym: Teho: Angiven effekt: Anført styrke: Putere de lucru:</p>	<p>Заданная мощность: Tahsis edilen güç: Stanovený výkon: Predpísaný výkon: Merkeeffekt: القدرة المبرمجة. Névléges teljesítmény : Določena jakost: Консумирана мощность: Määratud võimsus. Nustatyta galia Noteiktā jauda Nazivna snaga:</p>	<p>1300 W</p>
---	--	--	---------------

	<p>Vitesse à vide: No-load speed: Leerlaufdrehzahl: Velocidad vacía: Velocità a vuoto: Velocidade no vácuo: Leerlaufdrehzahl: Ταχύτητα αδράνειας: Prędkość bez bciążenia: Tyhjäkäyntinopeus Tomgångshastighet: Hastighed i ubelastet tilstand: Viteza în gol:</p>	<p>Скорость вращения на холостом ходу: Boşalma hızı: Rychlost naprázdno: Rýchlosť pri chode naprázdno: Tomgångshastighet: السرعة على الفراغ. Üres sebesség: Prosti tek: Скорост на празни обороти: Kiirus tühikäigul Tušćio prietaiso greitis Tukšgaitas ātrums Brzina praznog hoda:</p>	<p>800-1750 min⁻¹</p>
--	--	--	----------------------------------

	<p>Porter des lunettes de sécurité : Wear protective eyewear : Schutzbrille tragen : Llevar puestas gafas protectoras : Portare de gli occhiali di sicurezza : Utilizar óculos de segurança : Draag een veiligheidsbril : Φοράτε προστατευτικά γυαλιά: Zakładać okulary ochronne : Käytä suojalaseja : Använd skyddsglasögon : Der skal benyttes sikkerhedsbriller : Purtati ochelari de protectie :</p>	<p>Наденьте защитные очки : Güvenlik gözlükleri takın : Používejte bezpečnostní brýle : Noste ochranné okuliare : Bruk vernebriller: حمل نظارات وقائية. Viseljen védőszemüveget : Nositi zaščitna očala : Да се използват защитни очила : Kandke kaitseprille Nešioti apsauginius akinius Valkät aizsargbrilles Nositi zaštitne naočale:</p>	×
---	--	--	---

	<p>Porter un masque anti-poussière : Wear a dust mask : Staubschutzmaske tragen : Llevar puesta una careta de protección contra el polvo : Indossare una mascherina anti-polvere : Utilizar uma máscara anti-poeira : Draag een stofmasker : Φορέστε μάσκα για τη σκόνη: Zakładać maskę przeciwpyłową Käytä pölysuojust : Bär mask mot damm : Der skal benyttes beskyttelsesmaske mod støv: Purtati mască anti-praf :</p>	<p>Наденьте респиратор : Toza karşı maske takın : Používejte masku proti prachu : Noste ochrannú masku proti prachu : Bruk en støvmaske: لبس قناع جراثيم للغبار. Viseljen porvédő maszkot Nositi zaščitno masko proti prahu: Да се използва защитна маска : Kandke tolmumaski. Dëvëti respiratorij Valkät aizsarg masku pret putekļiem Nositi masku za zaštitu od prašine:</p>	×
---	---	--	---

	<p>Porter une protection auditive : Wear hearing protective equipment: Gehörschutz tragen: Llevar puesta una protección auditiva: Portare una protezione uditiva: Utilizar uma protecção auditiva: Draag gehoorbeschermers: Φοράτε προστασία ακοής: Zakładać słuchawki ochronne Käytä kuulosuojaimia: Bär hörselskydd: Der skal benyttes høreværn: Purtati căști de protectie auz:</p>	<p>наденьте средства звуковой защиты: İşitsel koruma aleti takın: Používejte ochranu sluchu: Noste ochranné slúchadlá: Bruk hørselsvern: لبس سماعة خضض الخرجي ج Viseljen fülvédőt Nositi zašito ušes: Да се използва слухови защитни средства: Kandke kõrvakaitset Nešioti apsaugā nuo triukšmo Valkät dzirdes aizsarglīdzekli Nositi štitnike protiv buke:</p>	×
--	--	---	---

	<p>Porter des gants : Use rubber gloves : Schutzhandschuhe tragen : Llevar guantes de protección : Indossare i guanti di protezione : Utilizar luvas de protecção : Draag veiligheidshandschoenen : Φορώντας γάντια: Używać rękawic ochronnych : Käytä suojakäsineitä : Använd skyddshandskar : Der skal benyttes handsker : Purtati mănuși :</p>	<p>Наденьте перчатки : Eldiven takın : Noste rukavice : Noste rukavice : Bruk hansker: لبس قفازات. Viseljen kesztyű t Nositi rokavice: а се използват предпазни ръкавици : Kandke kindaid Müvēti pirštines Valkät cimdus Nositi zaštitne rukavice:</p>	×
---	---	--	---

	<p>Lire les instructions avant usage : Read the instructions before use : Vor Einsatz des Geräts Anweisung lesen : Léase las instrucciones antes de usar : Leggere le istruzioni prima dell'uso : Ler as instruções antes da utilização : Lees voor het gebruik de instructies : Διαβάστε τις οδηγίες πριν από τη χρήση: Zapoznać się instrukcją przed użyciem : Lue ohjeet ennen käyttöä : Läs anvisningarna före användning : læs instruktionerne før brug Înainte de utilizare, citiți instrucțiunile :</p>	<p>Внимательно прочитайте следующие инструкции : Kullanmadan talimatları okuyunuz : Pozorně si přečtěte následující pokyny : Pred použitím si prečítajte pokyny : Les bruksanvisningen før bruk: اقرأ التعليمات قبل الاستخدام. használat előtt olvassuk el az utasítást : Pred uporabo preberite ustrezna navodila Прочетете указанията за употреба : Enne kasutamist lugege instruksiooni Prieš naudojimą perskaityti instrukciją izlasīt instrukcijas pirms lietošanas Pročitati upute prije uporabe:</p>	X
---	--	---	---

	<p>Conformité européenne Conforms to EC standards : CE-Konformität : Cumple con las directivas CE : Conforme alle norme CE : Conforme às normas CE : Voldoet aan de EG-normen : Ευρωπαϊκή Συμμόρφωση Zgodność z normami CE : EU-standardien mukainen : EU-standardien mukainen : Overholder EU standarderne : Conform cu normele europene:</p>	<p>соответствие европейским стандартам: Avrupa uygunluk : evropská shoda : európska dohoda : Europeisk konformitet مطابق للمواصفات الأوروبية. evropska ustreznost : európai megfelelőség : Съответствие с европейските норми : Euroopa Liidu vastavusmärk Europinių normų atitikima Atbilstība Eiropas standartiem Evropska sukladnost</p>	X
---	--	--	---

	<p>Danger : Danger : Gefahr : Peligro : Pericolo : Perigo : Gevaar : Κίνδυνος: Niebezpieczeństwo : Vaara : Fara : Fare : Pericol :</p>	<p>Опасно : Tehlike : Nebezpečí : Nebezpečenstvo : Fare: خطر. Veszély : Nevarnost: Опасност : Oht Pavojus Bīstamība Opasnost:</p>	X
---	--	---	---

	<p>Poids : Weight : Gewicht : Peso : Peso : Peso : Gewicht : Βόρος : Masa : Paino : Vikt : Vægt : Greutate :</p>	<p>Bec : Ağırlık : Hmotnost : Hmotnosť : Vekt: الوزن. Súly : Teža : Тегло : Raskus Svoris Svars Težina</p>	4,3 kg
---	--	--	--------

		M14
---	--	-----

 L_pA	Niveau de pression acoustique :	Уровень акустического давления. :	97 dB (A)
	Acoustic pressure level :	Akustik basınç seviyesi :	
	Schalldruckpegel :	Hladina akustického tlaku :	
	Nivel de presión acústica :	Hladina akustického tlaku :	
	Livello di pressione acustica :	Lydtryknivå :	
	Nível de pressão acústica :	مستوى الضغوط السمعي.	
	Niveau akoestische druk :	A hangnyomás szintje :	
	Στόμην ηχητικής πίεσης :	Nivo akustičnega pritiska :	
	Poziom mocy akustycznej :	Равнище на акустично налягане :	
	Käytä kuulosuojaimia :	Helirõhu tase :	
	Ljudtrycksnivå :	Akustinio spaudimo lygis :	
Lydtryk :	Akustiskå spiediena līmenis :		
Nivel presiune acustică :	Razina zvučnog tlaka :		

 L_{WA}	Niveau de puissance acoustique :	уровень мощности звука :	108 dB (A)
	Acoustic power level :	Akustik basınç seviyesi :	
	Schalleistungspegel :	Hladina zvukového výkonu :	
	Nivel de potencia acústica :	Hladina zvukového výkonu :	
	Livello di potenza acustica :	Lydeffektivnivå :	
	Nível de potência acústica :	مستوى الضوضاء ج.	
	Niveau akoestisch vermogen :	a hangnyomás szintje :	
	Επίπεδο ισχύος ήχου :	Nivo akustične jakosti :	
	Poziom mocy akustycznej :	Равнище на вибрации :	
	Käytä suojalaseja :	Helivõimsuse tase :	
	Ljudstyrkenivå :	Triukšmo lygis :	
Lydstyrke :	Akustiskās jaudas līmenis :		
Nivel putere acustică :	Razina zvučne snage :		

NIVEAU SONORE D'ÉMISSION :

A VIDE

Pression acoustique LpA poste opérateur
Incertitude

97 dB
3

Puissance acoustique LWA
Incertitude

108 dB
3

Valeurs déterminées suivant le code d'essai de l'annexe B de la norme EN 61029-1 avec emploi des normes de base ISO 11201 et ISO 3744.

Les niveaux de pression acoustique obtenus in situ dépendent:

- Des niveaux réels de la machine considérées, en prenant en compte les incertitudes déclarées;
- Du local et de l'installation de la machine. Préférez une pièce dont l'acoustique est plus feutrée. Evitez les pièces vides à grande résonance. Placez vous auprès d'une fenêtre le cas échéant.
- Des outils montés, des pièces travaillées, des réglages choisis,...

	Niveau de vibration :	Уровень вибрации :	10,41 m / s ²
	Hand/arm vibration level :	Titreşim seviyesi :	
	Vibrationspegel Hand/Arm :	Úroveň vibrací :	
	Nivel de vibración mano/brazo :	Hladina vibrácií :	
	Livello di vibrazione mano/braccio :	Vibrasjonsnivå :	
	Nível de vibração mão/braço :	مستوى الارتجاج ج.	
	Trillingsniveau hand/arm :	Vibrációsztint :	
	Επίπεδο κραδασμών :	Nivo vibracij :	
	Poziom wibracji rózka/ramióz :	Равнище :	
	Tärinätaso :	Vibrācijas līmenis.	
	Vibrationsnivå hand/arm :	Vibracijos lygis	
Vibrationsniveau :	Vibratsiooni tase		
Nivel vibrații :	Razina vibracije:		

VIBRATIONS:

Total des valeurs de vibration (somme vectorielle des trois directions) déterminée selon EN 60745 :

a 10,41 m/s²
Incertitude K 1,5 m/s²

L'amplitude d'oscillation peut être utilisée comme valeur de comparaison d'outils électroportatifs.

Attention : si l'outil électroportatif est utilisé pour d'autres applications, avec d'autres outils de travail, l'amplitude d'oscillation peut être différente.

	<p>Soumis à recyclage Subjected to recycling Sujeto a reciclaje Sottoposti a riciclaggio Sujeitos à reciclagem Não deite no lixo : Niet wegwerpen : Υπόκειται σε ανακύκλωση Nie wyrzucac : Älä heitä pois luontoon : Batteriet får inte kastas : Bortkast det ikke: Nu le auncati :</p>	<p>Подлежит переработке Atmayiniz : Nevyhadzujte je do bežného odpadu : Neodhadzovat : Gjenvinningspliktigt فلا ترمدها دلنذا في القمامة. ne mečíte1 Ne odvržite ga/jih vstran : Taaskasutusse kuuluac Ärge visake seda minema : Nemetykíte : Nemest : Podvrgnuto recikliranju</p>	X
---	---	---	---

Recyclage des déchets :

Les outils, accessoires et leur emballages doivent suivre une voie de recyclage adaptée. Conformément aux directives Européenne 2012/19/UE et 2006/66/CE, les composants d'un produit doivent être séparés, collectés, recyclés ou éliminés en conformité avec les réglementations environnementales en vigueur. Les appareils, batteries, piles, huiles, emballages devront être déposés dans les systèmes d'élimination des déchets spéciaux tels que déchetteries. Renseignez-vous auprès de votre commune pour connaître l'organisme le plus proche à même de retraiter ou de collecter ces déchets.

	<p>Recyclable, soumis au tri sélectif Recyclable, subject to recycling Recyclingföhige, unterliegen Recycling Reciclables, sujetos a reciclaje Riciclabili, soggetti a riciclaggio Recicláveis, sujeito à reciclagem Recycleerbare, onderworpen aan recycling Ανακυκλώσιμο, υπόκειται σε επιλεκτική διαλογή Opakowanie nadaje się do recyklingu podlegają recyklingu Kierrätettävien pakkausten kohteena kierrätys Återvinningsbara förpackningar omfattas återvinning Рециклираци се опаковки подлежат на рециклиране Genanvendelig underlagt genbrug</p>	<p>Reciclable sub rezerva reciclare Повторно упаковка подлежит вторичной переработке Geri dönüştürülebilir ambalaj konusu Recyklovateľné podléhajúci recyklaci Recyklovateľné podliehajúce recyklácii Resirkulerbar, med förbehold om selektiv sortering ريودنلا دا زال يفرغين ريودنلا دا زال فريودنلا فويل فريودنلا Újrahasznosítható csomagolás alá újrahasznosítás Reciklirati predmet recikliranja Pakendite suhtes ringlussevõtu Pärstrådājams iepakojuoms otrreizējai pārstrādei Perdirbamų taikomos perdirbimo Može se reciklirati, podložno selektivnom sortiranju</p>	X
---	--	--	---

	<p>Classe d'isolement : 2 Insulation class : 2 Isolierklasse: 2 Aislamiento clase :2 Isolamento classe :2 Isolamento classe :2 Isolatie Klasse : 2 Κατηγορία μόνωσης: 2 Izolacija Klazy :2 Eristysluokka :2 Isolering Klass :2 Isoleringsklasse 2 Clasă izolatie :2</p>	<p>Класс изоляции 2 : Yalitim derecesi :2 Třída izolace :2 Izolačný systém 2 Isolatsjonsklasse: 2 فئة ال عزل 2. Szigetelési osztály :2 Razred izolacije :2 Инструмент Клас :2 Isolatsiooniklass 2 Izolācijas rūšis 2 Izolācijas klase 2 Izolacija klasa: 2</p>	X
--	---	--	---

PSB 1300

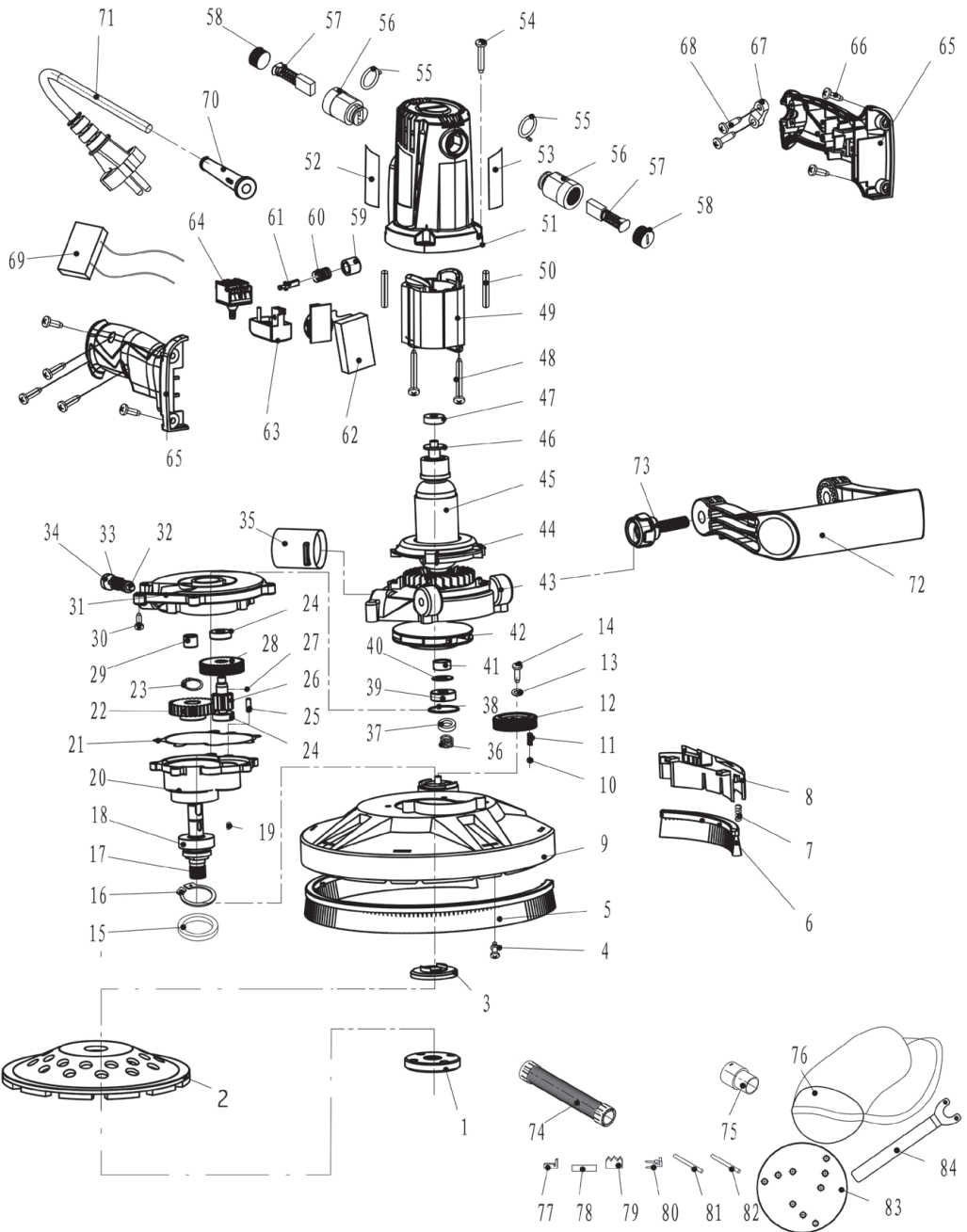

DECLARATION DE CONFORMITE
 VERKLARING VAN OVEREENSTEMMING
 DECLARACION DE CONFORMIDAD
 DICHIARAZIONE DI CONFORMITA
 KONFORMITÄSERKLÄRUNG
 DECLARATION CONFORMITY
 DECLARAÇÃO DE CONFORMIDADE
 DEKLARACJA ZGODNOSCI Z NORMAMI
 OM ÖVERENSSTÄMMELSE
 VAATIMUSTENMUKAISUUSVAKUUTUS
 OVERENSSTEMMELSESERKLÆRING
 Δήλωση συμμόρφωσης

DECLARAȚIE DE CONFORMITATE
 VYHLÁSENIE ZHODY
 Декларация соответствия
 SAMSVARSERKLÆRING
 Uygunluk beyanı
 التصريح بالامتثال
 PROHLÁŠENÍ SHODY
 EGYZSÉGI NYILATKOZAT
 Декларация за съответствие с нормите
 IZJAVA O SKLADNOSTI
 DEKLARACIJA
 ATITIKTIES DEKLARACIJA
 KINNITUS
 IZJAVA O SUKLADNOSTI

Le soussigné,
 Ondergetekende,
 Der Unterzeichner,
 O abaixo assinado,
 Undertecknad,
 Долуподписаният
 Undertegnede
 Subsemnatul,
 Я, нижеподписавшийся,
 Imzalayan,
 Niže podepsany,
 Tollau pasirasęs

Déclare par la présente que,
 Verklaart hiermede dat,
 Erklärt hiermit daß,
 Declara pela presente que,
 Förklarar härmed att
 Заявява с настоящото
 erklærer hermed, at
 Declar prin prezenta că,
 настоящим подтверждаю, что
 Mecut belgeyle beyan ediliyor ki,
 timto prohlasuje, že,
 Pareiskia, kad,

Personne autorisée à
 constituer le dossier technique :
 Christophe HUREL



FAR GROUP EUROPE
 192, Avenue Yves Farge
 37700 St. Pierre-des-Corps
 FRANCE

El suscrito,
 Il sottoscritto,
 The undersigned,
 Nijej podpisany
 Allekirjoittanut,
 Ο κάτωθι υπογεγραμμένος,
 Nizšie podpisany
 Undertegnede,
 Subsemnatul,
 ال ذوق ع انداه
 Alulirott,
 Podpisani,
 Apakša parakstijies
 allakirjutanu
 Dolje potpisani,

Declara por la presente, que,
 Dichiare che,
 Declares that,
 Oświadczam niniejszym, że
 Ilmoittetaan täten että,
 Δια του παρόντος δηλώνει ότι,
 týmto vyhlasuje, že

يصرح استنادا على ذلك
 Kijeleptem, hogy a készülék Izjavlja da,
 Pareiskia, kad,
 Ar šo apliecinā, ka,
 Kinnitab, et
 izjavljuje u ovom dokumentu da je

Ponceuse surfaceuse de sol / resurfacing floor sander / Scheuermaschine mit langer stange / Lijadora de reparación de pisos / Levigatrice per pavimenti / recapeamento lixadeira chão / Schuurmachine voor vloervernieuwing / Τριβείο επιφανειών δαπέδου / Nawierzchni podłogi Sander / Betonlihomakone / Betongslip / Sander etaj pilning / Betonšlibermaskine / Sander etaj resurfacing / Sander полшлифовка / Sander zemin yenileme / Sander patro resurfacing / Sander poschodje resurfacing / درند تفرز و تهرند / درند تفرز و تهرند / Sander padló pályás / Sander korrusel koormimine / Sander gridas seguna atjaunošanu / Pjūkli grindų klojimas / Brusilica za podnu površinu

code

FARTOOLS / 115190 / PSB 1300 / R7502

Est conforme et satisfait aux directives et normes CE,
 In overeenstemming is met en Voldoet aan EG richtlijnen,
 Den folgenden EU-Bestimmungen entspricht,
 Respeita e está em conformidade com as normas CE,
 Överensstämmer med och uppfyller EG-standarder,
 Съответства и отговаря европейските норми
 Er i overensstemmelse med og overholder EU standarderne
 Este conform și satisfacă normele CE
 полностью соответствует и удовлетворяет
 требованиям стандартов ЕС
 CE şartlara uygundur,
 odpovídá normám ES.
 Atitinka ir atitinka EB direktyvas ir standartus,

Cumple con la directivas de la CE,
 E conforme alle direttive CEE,
 Complies with the EEC directives and standards,
 Odporviada normom UE,
 Täyttää EU-vaatimukset,
 Συμμορφώνεται και ικανοποιεί τις οδηγίες και τα πρότυπα CE,
 zodpovedá normám ES.
 Samsvarer med og tilfredsstiller CE-direktiver og standarder,
 بیان الحوازی مطابق و یلی می آید م جموعه الدول الأوروبية
 kielgiti a CE szabványok előírásait.
 Je v skladu z in izpolnjuje norme Evropske skupnosti.
 Atbilst un atbilst EK direktivas un standartus,
 Vastab ja vastab EU direktiividele ja standarditeile,
 Sukladan i ispunjava direktive i standarde CE,

2006/42/EC 2014/30/EU 2011/65/EU 2015/863/EU

EN IEC 55014-1:2021
 EN IEC 55014-2:2021
 EN IEC 61000-3-2:2019
 EN 61000-3-3:2013+A1:2019
 EN 60745-1:2009+A11:2010
 EN 60745-2-3:2011+A2:2013+A11:2014+A12:2014+A13:2015
 EK9-BE-88:2014

Christophe HUREL,
 Président Directeur Général
 21/11/2022
 Fait à St. Pierre-des-Corps

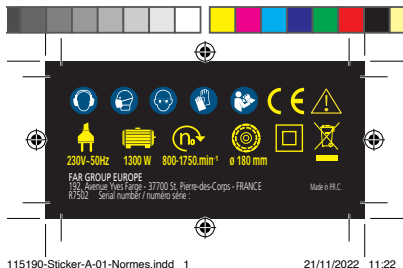

115190-Sticker-A-01-Normes.indd 1

21/11/2022 11:22



115190-Sticker-A-01-Normes.indd 2

21/11/2022 11:22

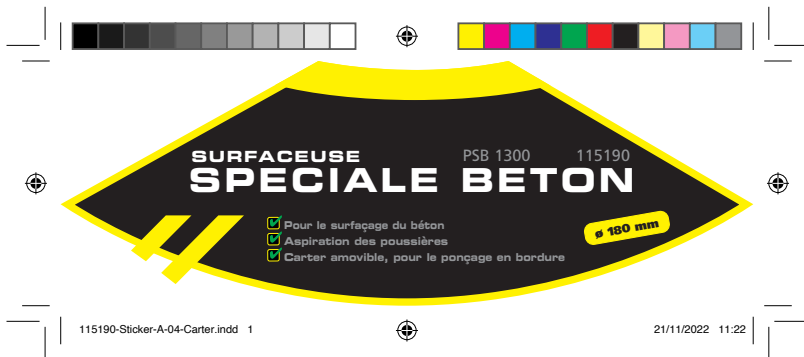
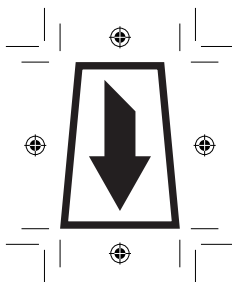

115190-Sticker-A-04-Carter.indd 1

21/11/2022 11:22

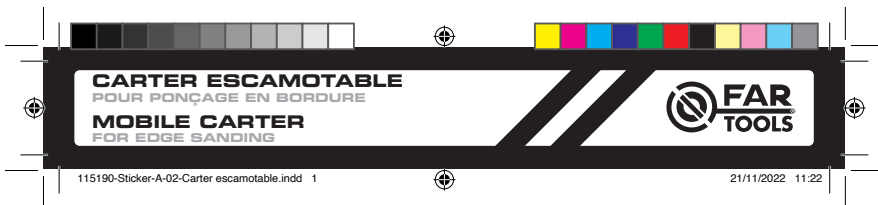

115190-Sticker-A-02-Carter escamotable.indd 1

21/11/2022 11:22

GARANTIE - WARRANTY



FR. GARANTIE

Cet outil est garanti contractuellement contre tout vice de construction et de matière, à compter de la date de vente à l'utilisateur et sur simple présentation du ticket de caisse. La garantie consiste à remplacer les parties défectueuses. Cette garantie n'est pas applicable en cas d'exploitation non conforme aux normes de l'appareil, ni en cas de dommages causés par des interventions non autorisées ou par négligence de la part de l'acheteur. La garantie ne s'applique pas sur les dommages causés par une défaillance de l'outil.

DE. GARANTIE

Die Garantiezeit für dieses Gerät in Bezug auf Konstruktions- und Materialfehler beträgt lt. Vertrag bei Vorlage des Kassensbons. Die Garantieleistung besteht im Ersatz schadhafter Teile. Die Garantie erlischt bei einem Einsatz des Geräts, der nicht normentsprechend ist, bei Schäden, die auf unsachgemäße Eingriffe zurückzuführen sind bzw. bei Nachlässigkeit seitens des Käufers. Die Garantie erstreckt sich nicht auf Schäden, die auf Fehlfunktionen des Geräts zurückzuführen sind.

IT. GARANTIA

Quest' attrezzo è garantito per contratto contro qualsiasi difetto di costruzione e di materia, a partire dalla data di vendita all'utente e su semplice presentazione dello scontrino. La garanzia consiste nel sostituire le parti difettose. Questa garanzia non è applicabile in caso di sfruttamento non conforme alle norme dell'apparecchio, né in caso di danni causati da interventi non autorizzati o da negligenza da parte dell'acquirente. La garanzia non si applica ai danni causati da un'avarìa dell'attrezzo.

EN. GARANTIE

This tool is guaranteed, in writing, against any defect in manufacture of parts from the date of sale, upon simple presentation of the sales slip. The guarantee is limited to the replacement of faulty parts. This guarantee is not applicable in the event of usage which is not conform with the intended usage of the apparatus, nor in the event of damage caused by unauthorised servicing or negligence on behalf of the purchaser. This guarantee does not apply to any damage caused by

the failure of this tool.

ES. GARANTIA

Esta herramienta se garantiza contractualmente contra todo defecto de construcción y materia, a partir de la fecha de venta a l' usuario y sobre simple presentación del recibo de caja. La garantía consiste en sustituir a las partes defectuosas. Esta garantía no es aplicable en caso de explotación no conforme a las normas del aparato, ni en caso de daños causados por intervenciones no autorizadas o por negligencia por parte del comprador. La garantía no se aplica sobre los daños causados por un fallo del herramienta.

NL. GARANTIE

Dit gereedschap heeft een garantie tegen constructiefouten en materiaaldefecten, die geldig is vanaf de aankoopdatum door de gebruiker, op vertoning van de kassabon. De garantie betreft de vervanging van de defecte onderdelen. Deze garantie is niet van toepassing indien het apparaat niet volgens de normen gebruikt is, noch in geval van schade veroorzaakt door oneigenlijk gebruik of nalatigheid van de koper. De garantie is niet van toepassing op schade voortvloeiend uit een defect van het gereedschap.

PT. GARANTIA

Esta ferramenta tem uma garantia contratual contra qualquer defeito de construção e de material, a partir da data de venda ao utilizador e sobre simples apresentação do talão da caixa. A garantia consiste em substituir as partes defeituosas. Esta garantia não é aplicável no caso de exploração não conforme as normas do aparelho, nem em caso de danos causados pelas intervenções não autorizadas ou por negligência da parte do comprador. A garantia não se aplica para os danos causados por uma falha da ferramenta.

ΕΛΛΗΝΙΚΑ

Αυτό το εργαλείο είναι συμβατικά εγγυημένο για οποιοδήποτε κατασκευαστικό και υλικό ελάττωμα, από την ημερομηνία πώλησης στον χρήστη και με την επίδειξη της απόδειξης πώλησης. Η εγγύηση ουσίσταται στην αντικατάσταση των ελαττωματικών εξαρτημάτων. Αυτή η εγγύηση δεν ισχύει σε περίπτωση λειτουργίας που δεν συμμορφώνεται με τα πρότυπα της συσκευής, ούτε σε περίπτωση ζημιάς που προκαλείται από μη εξουσιοδοτημένες επεμβάσεις ή αμέλεια εκ μέρους του αγοραστή. Η εγγύηση δεν ισχύει για ζημιές που προκαλούνται από αστοχία εργαλείου.

PL. GWARANCJA

Narz dzie jest objte gwarancja na wszelkie wady konstrukcyjne i materiałowe, licząc od daty sprzedaży u ytkownikowi i

po okazaniu paragonu kasowego. Gwarancja obejmuje wymian cz Aci wybrakowanych. Gwarancja nie znajduje zastosowania w przypadku u ytkowania niezgodnego z normami urzadzenia, ani w przypadku szkód spowodowanych działaniami niedozwolonymi lub zaniedbaniami ze strony nabywcy. Gwarancja nie obejmuje szkód powstałych z powodu upadku urzadzenia.

SV. GARANTI

Detta verktyg har en avtalsenlig garanti mot konstruktions och materialfel, från och med tidpunkten för användarens inköp och genom uppvisning av kassakvittot. Garantin består i att ersätta de bristfälliga delarna. Denna garanti gäller inte om användningen inte motsvarar apparatens standarder, inte heller vid skador som orsakas av ej tillätna ingrepp eller på grund av köparens vårdslöshet. Garantin gäller inte forskador som orsakats av att verktyget fungerat bristfälligt.

FI. TAKUUK

Tämän laitteen takuu on voimassa sopimuksenmukaisesti kattaa kaikki rakenne- ja materiaali- ja luokien ostopäivästä kassakuittia vastaan. Takuu sisältää viallisten osien korvaamisen. Takuu ei korvaa ohjeidenvastaista käyttöä, eikä vaihtuuttamattomien henkilöiden käsittelystä tai ostajan huolimattomuudesta aiheutuneita vahinkoja. Takuu ei vastaa myöskään toimintahäiriöistä aiheutuneita vahinkoja.

BG. Гаранция

Този инструмент е под договорна гаранция срещу всякакъв дефект в изработката и използваните материали, считано от датата на продажба на потребителя и само срещу представяне на касовата бележка. Гаранционното обслужване се състои в замяна на дефектните части. Настоящата гаранция не е валидна когато апаратът се използва по начин, несъответстващ на стандарта за работа с него, както и в случая на щети, нанесени от неоторизирани лица, или вследствие на проявена небрежност от страна потребителя. Гаранцията не покрива щети, произтекли вследствие на техническа неизправност на апарата.

DA. GARANTI

Dette værktøj er dækket af en garantikontrakt for konstruktions- og materialefej, som gælder fra købsdatoen ved visning af kassebonen. Garantien består i at udskrifte de defekte dele. Garantien dækker ikke fejl opstået som følge af anvendelse, som ikke overholder standarderne for apparatet, eller

SERVICE APRÈS VENTE - AFTER SALE SERVICE

FARGROUP EUROPE - 192, Avenue Yves Farge - 37700 St. Pierre-des-Corps - FRANCE

fargroup@fargroup.net

GARANTIE - WARRANTY



skader opstået ved ikke autoriserede indgreb eller sløsethed fra brugerens side. Garantien dækker ikke skader opstået, fordi værktøjet har svigtet.

RO. GARANTIE

Acest aparat este garantat din punct de vedere contractual împotriva tuturor viciilor de construcție și de material, începând de la data vânzării lui către utilizator și la simpla prezentare a bonului de casă. Garanția constă în înlocuirea componentelor defecte. Această garanție nu se aplică în cazul exploatarei în alt mod decât cel recomandat de normele aparatului și nici în caz de stricăciuni provocate de intervenții neautorizate sau prin neglijența cumpărătorului. Garanția nu se aplică asupra pagbelor cauzate de o defectare a aparatului.

RU. ГАРАНТИЯ

Данное изделие обладает имеющей, силу контракта гарантией, покрывающей все возможные дефекты изготовления и материала. Гарантия вступает в силу с даты продажи изделия пользователю, для этого достаточно сохранить и предъявить полученный в кассе чек. Гарантия обязывает изготовителя заменить дефектные части изделия. В случае не соответствующего нормам использования изделия, несанкционированного демонтажа или ремонта или небрежного обращения действие гарантии прекращается. Гарантия не покрывает ущерба, возникшего в результате сбоя в работе изделия.

TR. GARANTİ

Bu araç, satis tarihinden itibaren, kullanıcının sadece vezne alıncısına sunmasıyla tüm urretim ve malzeme hatasına karşı garantilidir. Garanti eksik olan kisimlari degistirmek icindir. Bu garanti aracin sartlarina uymay olmayan isleme durumunda, izlen verilmeyen kullanimlardan kaynaklanan hasarlarda veya alıcının istegi durumunda uygulanmaz. Garanti malzemenin bir eksikliginden meydana gelen bir zararda uygulanmaz.

CS. ZÁRUKA

Pro tento nástroj platí smluvní záruka na všechny výrobní a materiálové vady od data prodeje uživateli a na základě předložení pokladního bloku. Záruka spočívá ve výměně vadných částí. Tato záruka neplatí v případě použití přístroje, které neodpovídá normám, ani v případě

škod způsobených nepovolenými zásahy nebo nedbalostí ze strany kupujícího. Záruka se nevztahuje na škody způsobené zavadou nástroje.

SK. ZÁRUKA

Pre tento nástroj platí zmluvná záruka na všetky výrobné a materiálové chyby od dátumu predaja užívateľovi a na základe predloženia pokladničného bloku. Záruka spočíva vo výmene chybných častí. Táto záruka neplatí v prípade použitia prístroja, ktoré nezodpovedá normám, ani v prípade škod spôsobených nepovolenými zásahmi alebo nedbalosťou zo strany kupujúceho. Záruka sa nevztahuje na škody spôsobené poruchou nástroja

AR. الضمان

على مجرد تقديم بطاقة الشراء يتعلم من تاريخ البيع إلى المشتري وبناءاً على فتي التصريحي عوفى المواد. اعتباراً أن هذه الة مضمونة تعاقدياً من أي اجزاء، ولأ في حالة تعرضه لتلفاً فإت حالة الإستخدام غير المطابق لمعايير الأيون هذا الضمان قابل للتطبيق فتي خلال الضمان فإي ستبدال الأجزاء العاطلة لا يطبق الضمان على الخردود الناتجة عن مخرضة أو فسي حالة العمل من قبل المشتري. إتاحة عن عوليات تتدل غير

HU. GARANCIA

Erre a szerszámra szerződéses garanciát vállalunk bármilyen gyártási és anyaghiba felmerülése esetére, a fogvasztó részére történt eladás napjától számítva, a penztári blokk egysejterü felmutatása ellenében. A garancia a hibás alkatrészek cserejére terjed ki. Ez a garancia nem érvényes, ha a keszüleket nem rendeltetésszerűen használták, sem illetéktelen beavatkozások, vagy a vásárló hanyagsága okozta károk esetén. A garancia nem fedezi azokat a károkat, melyeket a szerszám hibás működése okozott.

SL. GARANCIJA

To gorde je z garancijsko pogodbo zašciteno proti vsem napakam v izdelavi in v sestavnem materialu od datuma prodaje naprej in ta velja ob predložitvi blagajniškega računa. Garancija velja za zamenjavo delov z napako. Ta garancija ne velja za uporabo orodja, ki ni v skladu z normami, predpisanimi za omenjeno orodje in za primere okvar, ki nastanejo zaradi nedovoljenih posegov na orodju ali zaradi malomarnega rokovanja kupca. Garancija ne velja za škodo, ki jo lahko povzroci okvara orodja.

ET. GARANTII

See tööriist kuulub lepingu järgi garantiiremonti arvestades alates müümise päevast ja kassaseksti alusel kasutajale kõigi konstruktsiooni- ja materjalivigade puhul. Garantii seisneb defektsete osade vahetamises. See garantii ei kehti

aparaadi normide ebatavalise eiramise puhul ega ostja poolt keelatud viisil kasutamises või hooletusetahtmises tulenevate kahjude korral. Garantii ei kehti seadme defektidest põhjustatud kahjude puhul

LV. GARANTĪJA

Šis prietaisys yra uztkirinamas kaip itin geros kokybes, nuo jo pardavimo datos iki jo panaudojimo, ir jam yra suteikiamas garantinis talonas. Garantijos metu galima pakeisti atsiradusius trumplataikius gedimus. Ši garantija netaikoma esant netinkamam naudojimui ar nesilaikant reikiam šio aparato vartojimo instrukcijų, tai pat paciam pirkeiui jį sugadinus. Garantija taip pat netaikoma, prietaisa naudojant ne pagal paskirti ir jį apgadinus.

LT. GARANTIJA

Šim darbarikam ir liguma noteikta garantija visiem defektiem, kas saistās ar konstrukciju un materiālu, sakot ar pardosanas datumu, kad mašīnu pardod lietotājam un vienkārsi uzradot kases ceku. Garantija iekļauj bojāto daļu nomaiņu. Ši garantija nav derīga, ja aparāts nav lietots saskaņā ar drošības noteikumiem, ne gadijums, ja bojājumi radušies nesankcionētas ielauksanas gadījumā vai arī pierceja nolaidības dēļ. Garantija nav derīga, ja bojājumi radušies darbarika defekta dēļ.

HR. JAMSTVO

Ovaj alat ima ugovorno jamstvo u slučaju bilo kakvih nedostataka u konstrukciji i materijalu, od datuma prodaje korisniku uz jednostavno predocenje racuna. Jamstvo se sastoji u zamjeni neispravnih dijelova. Ovo se jamstvo ne primjenjuje u slučaju uporabe i eksploatacije koja nije sukladna standardima uređaja, niti u slučaju štete uzrokovane neovlaštenim intervencijama ili nemarom kupca. Jamstvo se ne primjenjuje na štetu uzrokovanu nekim nedostatkom alata.

SERVICE APRÈS VENTE - AFTER SALE SERVICE

FARGROUP EUROPE - 192, Avenue Yves Farge - 37700 St. Pierre-des-Corps - FRANCE

fargroup@fargroup.net



FAR GROUP EUROPE

Une société du groupe **SIGMA**

192, Avenue Yves Farge
37700 St. Pierre-des-Corps
FRANCE

fartools.com

