

CC 430 - 180032

MEJIX[®]

COUPE CARREAUX MANUEL (Notice originale)

- EN - MANUAL TILE CUTTER (Original manual translation)
- DE - FLIESENSCHNEIDMASCHINE (Übersetzung aus dem Original-Anleitung)
- NL - TEGELSNIJMACHINE (Vertaling van de originele instructies)
- IT - TAGLIPIASTRELLE (Traduzione dell'avvertenza originale)
- ES - CORDATORA DE LOSAS (Traducción del manual de instrucciones original)
- PT - CORTADOR DE CERAMICA MANUAL (Tradução do livro de instruções original)

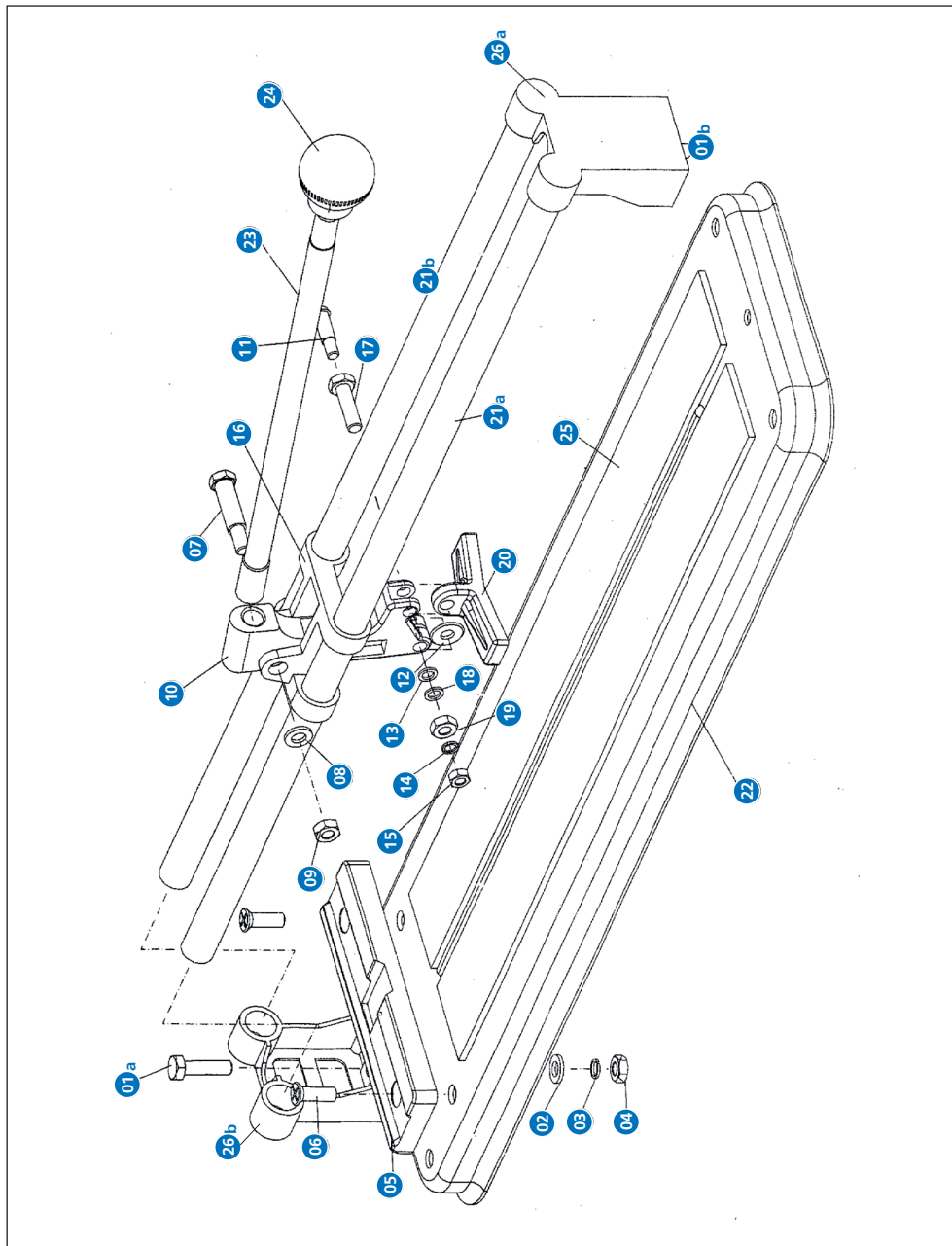

CC 430 180032

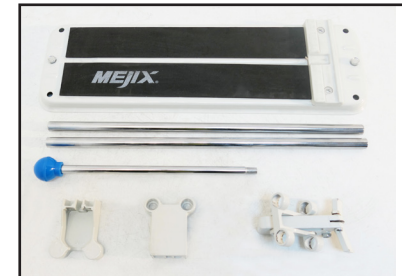
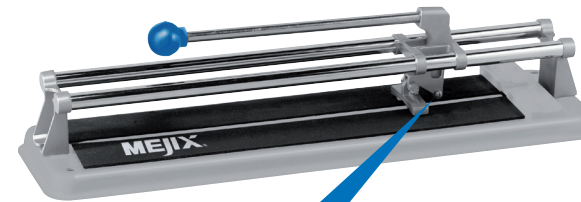

Changement MOLETTE COUPANTE
Cutting wheel / Schneidrändelrad /
Snijskartelwieletje / Rotella di taglio /
Rueda cortante / Roda de corte



Réf. : 180100

1,5 mm
Ø6 ø15 mm

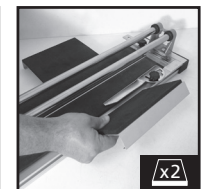
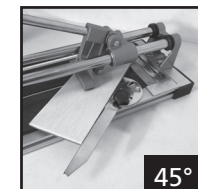
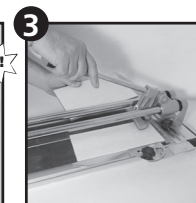
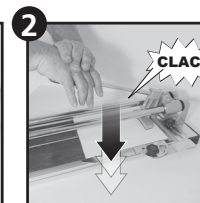
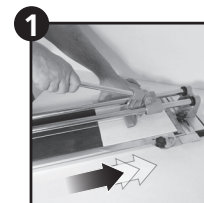
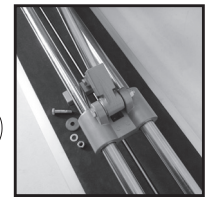
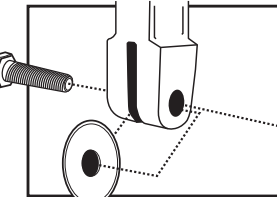
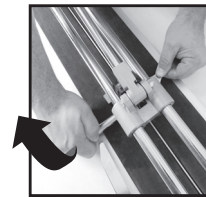
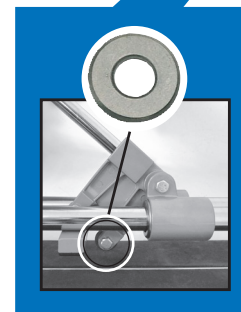

CC 430

180032

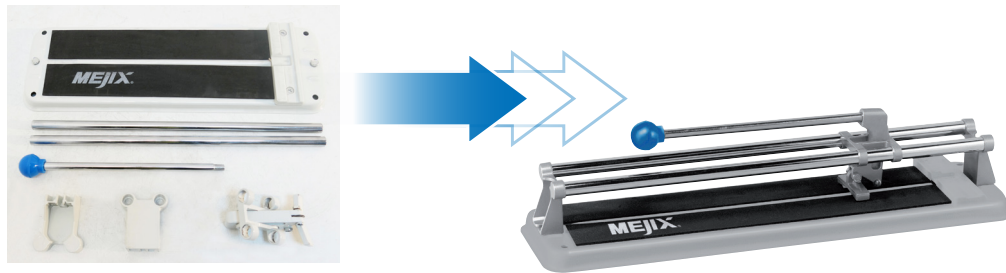

MERCI !



En consacrant seulement quelques minutes au montage de votre coupe carreaux **MEJIX**, vous permettez d'en diminuer l'impact environnemental !

Livrer cet outil non-monté permet une réduction de 55 % du volume de son emballage, et abaisse ainsi ses émissions de gaz à effet de serre :

- il utilise moins de ressources naturelles,
- son volume transporté est nettement plus faible.

