

CAPACITÉ/PORTE :
RAIL :
DÉPLACEMENT :

40 Kg
ALUMINIUM
PLIANT

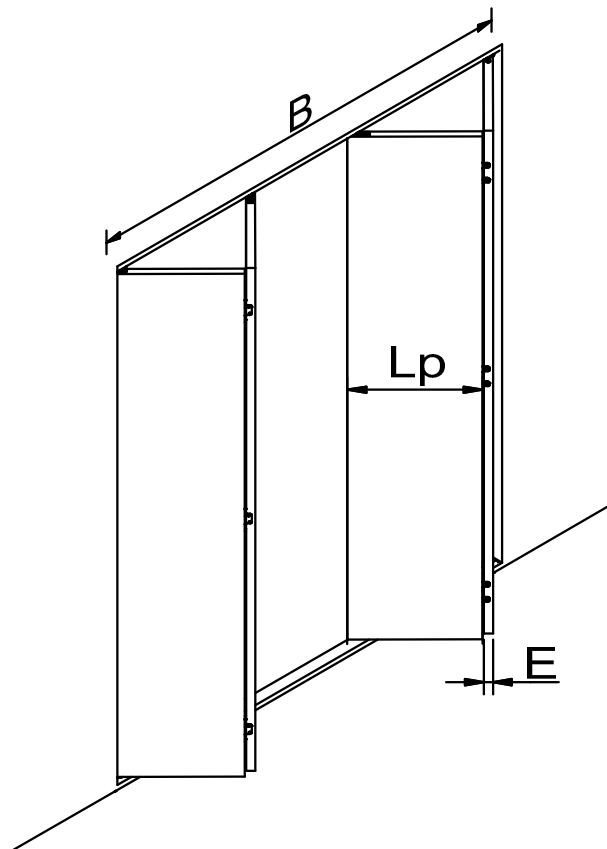

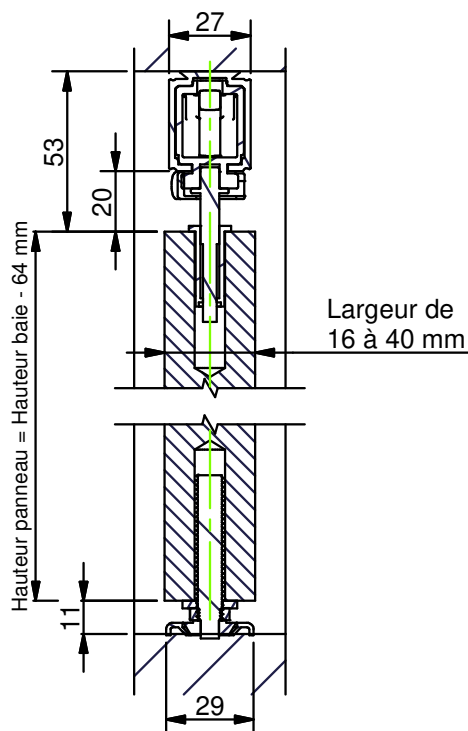



Système pliant pour portes d'intérieur, montage plafond et applique



KITS

Contenu	Pour	L rail	Réf.
1 rail alu anodisé 1 garniture pour 2 ou 4 portes	2 vantaux	1200	TANGO40-120
	2 vantaux	1500	TANGO40-150
	2+2 vantaux	1800	TANGO40-180
	2+2 vantaux	2000	TANGO40-200
	2+2 vantaux	3000	TANGO40-300
1 garniture pour 2 portes sans rail	2 vantaux		TANGO42

CONTENU GARNITURES

	Désignation	2 Vtx	2+2 Vtx
	Montures avec roulements à billes et galets en matière plastique	1	2
	Pivot haut 21613 - 21634 - 21734	1	2
	Pivot bas V132-022	1	2
	Charnière 1504C3	3	6
Clé de réglage, vis de pose, notice de montage			

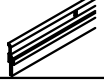
ACCESSOIRES

	Désignation	Référence
	Charnière à bille	1504PI
	Brosse d'étanchéité 15 mm à visser	1150/105
	Brosse 5 mm adhésive	63A5/1200
	Support équerre pour fixation murale	11013

LARGEUR PANNEAUX (750 mm maxi)

	Lp (mm)	J=	E (mm)
TANGO40-120 TANGO40-150	$Lp = \frac{B - 2J - 1,2}{2}$	2	16 < E ≤ 22
		3	22 < E ≤ 28
		4	28 < E ≤ 32
		6	32 < E ≤ 40
TANGO40-180 TANGO40-200 TANGO40-300	$Lp = \frac{B - 2J - 3,6}{4}$	2	16 < E ≤ 22
		3	22 < E ≤ 28
		4	28 < E ≤ 32
		6	32 < E ≤ 40

Sous réserve de modification sans préavis