

FAR TOOLS



MF 35PLASTER Professional Machine

- FR** *Aspirateur à décolmatage (Notice originale)*
- EN** *Decluttering vacuum cleaner (Original manual translation)*
- DE** *Decluttering Staubsauger (Übersetzung aus dem Original-Anleitung)*
- ES** *Aspiradora desordenada (Traducción del manual de instrucciones original)*
- IT** *Aspirapolvere di decluttering (Traduzione dell'avvertenza originale)*
- PT** *Aspirador decluttering (Tradução do livro de instruções original)*
- NL** *Ophelderende stofzuiger (Vertaling van de originele instructies)*
- EL** *Ηλεκτρική σκούπα απολύμανσης (Μετάφραση από τις πρωτυπες οδηγίες)*
- PL** *Odkurzacz do odpryskania (Tłumaczenie z oryginalnej instrukcji)*
- FI** *Decluttering pölyn imuri (Käännös alkuperäisestä ohjeet)*
- SV** *Decluttering vysávač (Översättning från originalinstruktioner)*
- BU** *Прахосмукачка с дефлуинг (Превод на оригиналната инструкция)*
- DA** *Declurende støvsuger (Oversættelse fra oprindelige brugsanvisning)*
- RO** *Aspirator de decluttering (Traducere din instrucțiunile originale)*
- RU** *Захламление пылесоса (Перевод с оригинальной инструкции)*
- TU** *Decluttering elektrikli süpürge (Orijinal talimatlar çeviri)*
- CS** *Declučující vysavač (Překlad z originálního návodu)*
- SK** *Decluttering vysávač (Preklad z originálneho návodu)*
- HE** *זמן טעינה (שואב אבק התזה)*
- AR** *قيلصل آل تاميل عتلل نم قم جرتللا قئي ابركه قس نكم*
- HU** *Decluttering porszívó (Fordítás az eredeti utasítások)*
- SL** *Decluttering sesalnik (Prevod iz izvirnih navodil)*
- ET** *Vaakum tolmuimeja (Tõlge originaal juhiseid)*
- LV** *Pramoninis plaunamas dulkiu siurblys (Tulkojumā no instrukcijas oriģinālvaloda)*
- LT** *Vaakum tolmuimeja (Vertimas iš originalių instrukcijas)*
- HR** *Usisni usisavač (Prijevod prema originalne upute)*



© FAR GROUP EUROPE

101213-A-20220715

fartools.com



5 min

Description et repérage des organes de la machine
Description and location of machine parts

A



Contenu du carton
Contents of box

C



Points de collecte sur www.quefaire-demarches.fr
Privilégiez la réparation ou le don de votre appareil !



Assemblage de la machine
Assembling the machine

D

01

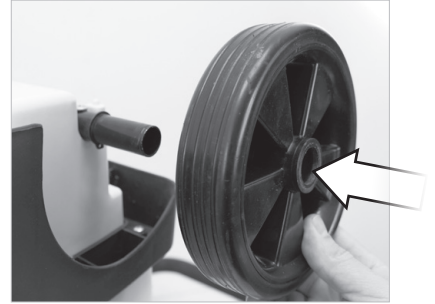
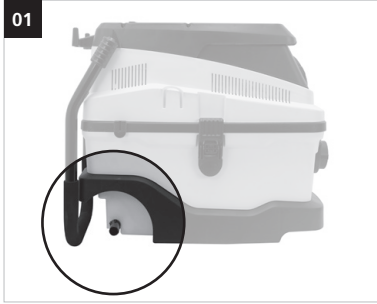

11

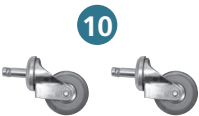
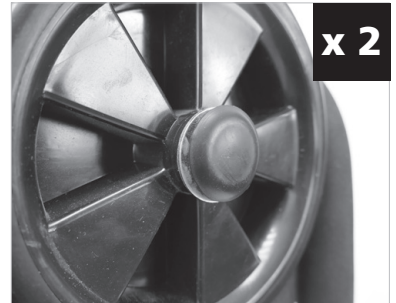
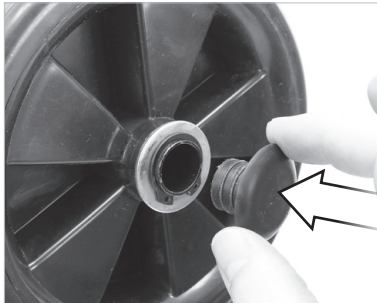
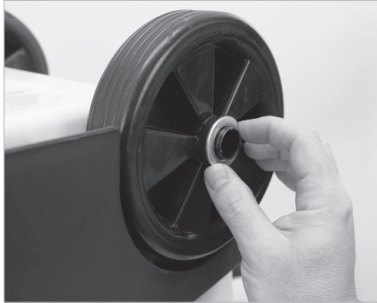

10

02



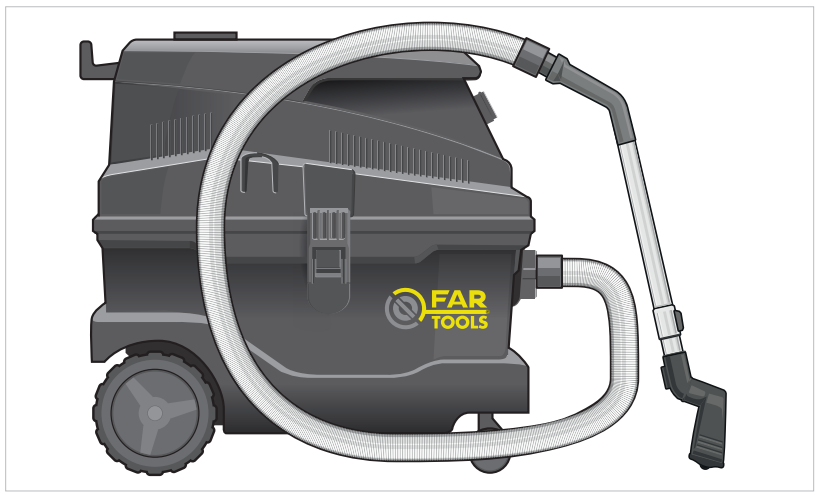
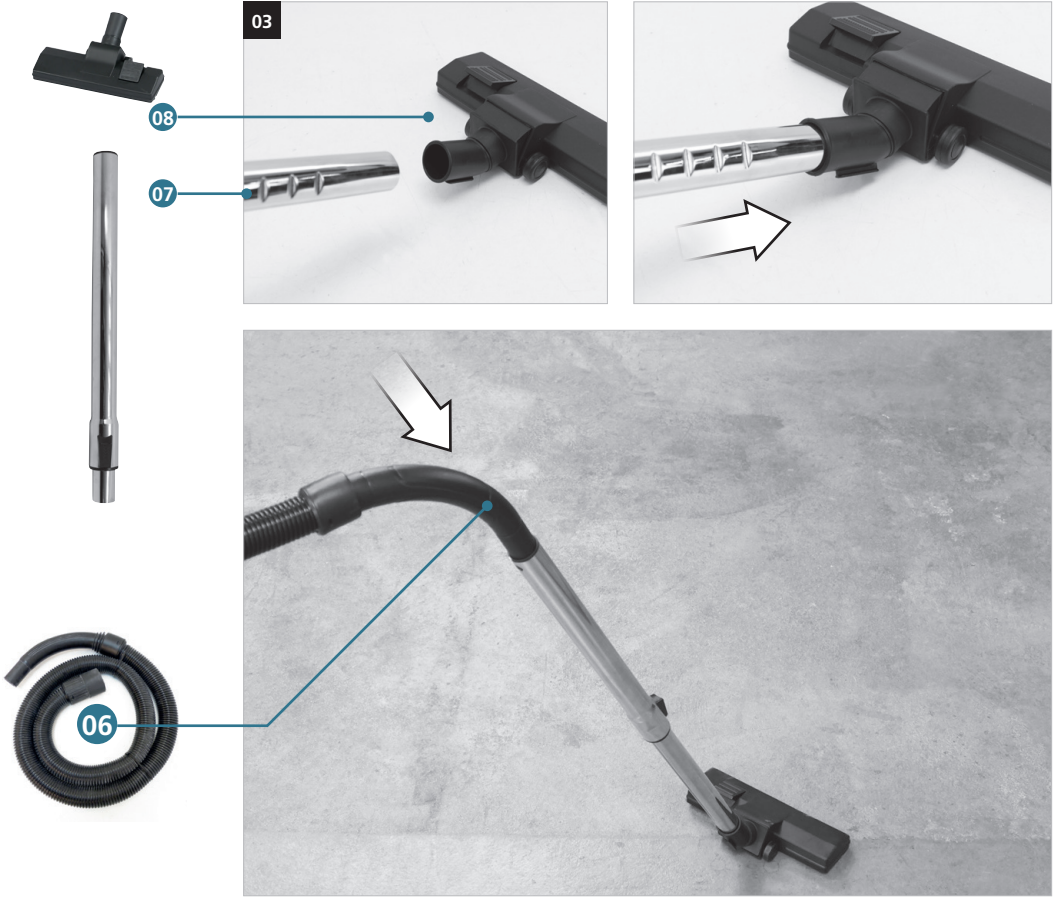

Assemblage de la machine
Assembling the machine

D

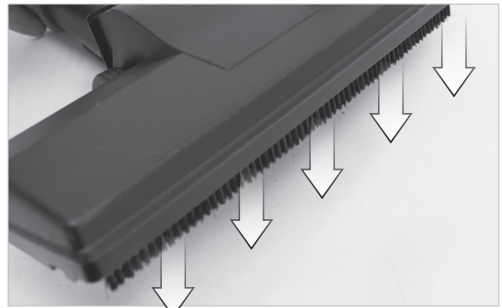
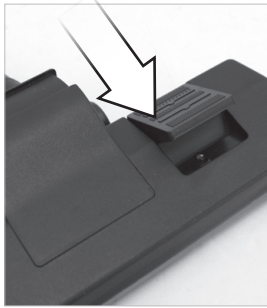
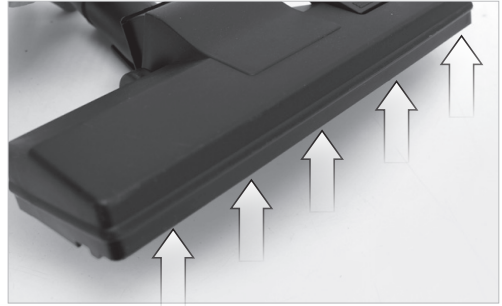
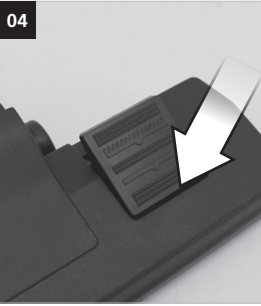

01



Aspiration particules fines uniquement (plâtre, béton)

Nur feine Partikel absaugen (Putz, Beton)
Alleen afzuiging van fijne deeltjes (gips, beton)
Succión solo de partículas finas (yeso, hormigón)
Succión apenas de partículas finas (gesso, concreto)
Aspirazione solo di particelle fini (intonaco, calcestruzzo)
Suction of fine particles only (plaster, concrete)

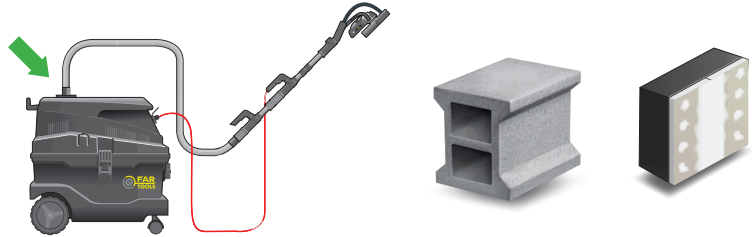

11

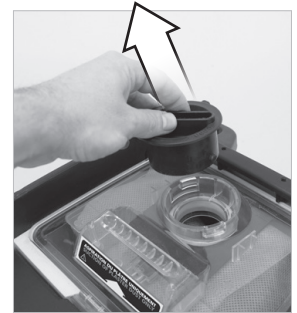

06

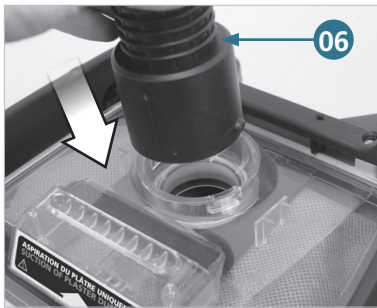

06

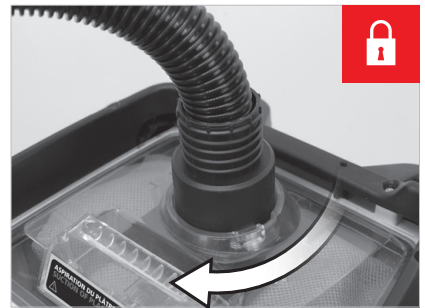

11

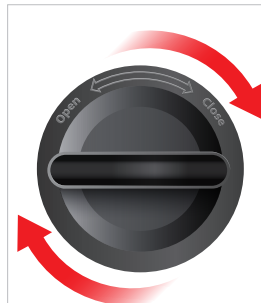

Aspiration particules fines uniquement (plâtre, béton)
Nur feine Partikel absaugen (Putz, Beton)
Alleen afzuiging van fijne deeltjes (gips, beton)
Succión solo de partículas finas (yeso, hormigón)
Succão apenas de partículas finas (gesso, concreto)
Aspirazione solo di particelle fini (intonaco, calcestruzzo)
Suction of fine particles only (plaster, concrete)

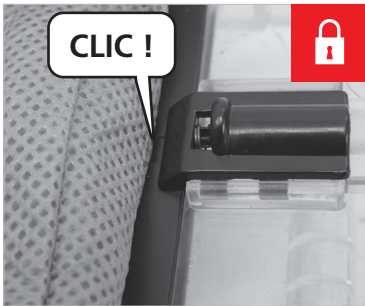
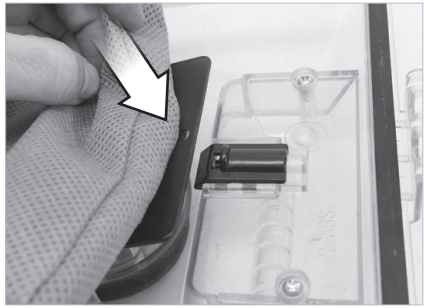
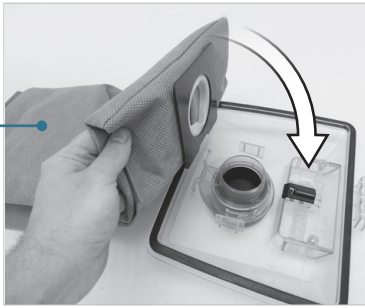
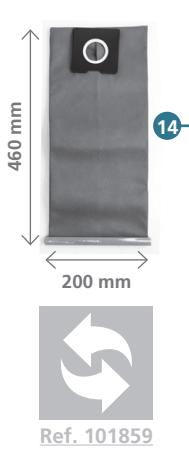
Aspiration particules fines uniquement (plâtre, béton)

Nur feine Partikel absaugen (Putz, Beton)
Alleen afzuiging van fijne deeltjes (gips, beton)
Succión solo de partículas finas (yeso, hormigón)
Sucção apenas de partículas finas (gesso, concreto)
Aspirazione solo di particelle fini (intonaco, calcestruzzo)
Suction of fine particles only (plaster, concrete)

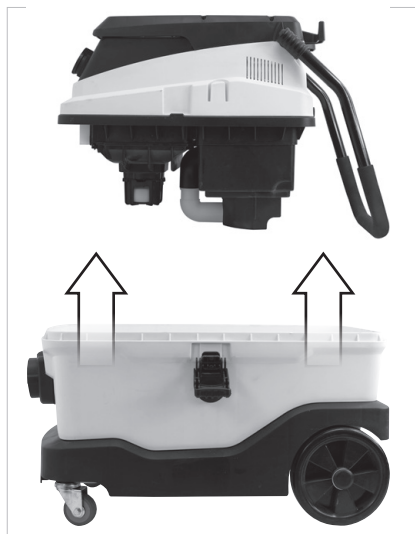
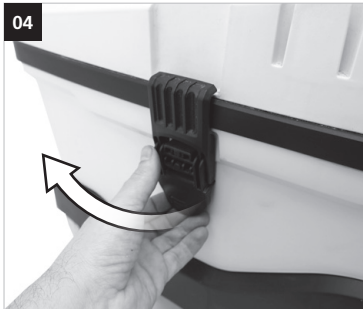

Aspiration particules fines uniquement (plâtre, béton)

Nur feine Partikel absaugen (Putz, Beton)
Alleen afzuiging van fijne deeltjes (gips, beton)
Succión solo de partículas finas (yeso, hormigón)
Succión apenas de partículas finas (gesso, concreto)
Aspirazione solo di particelle fini (intonaco, calcestruzzo)
Suction of fine particles only (plaster, concrete)



05

7 Litres maximum
Maximal 7 Liter
Maximaal 7 liter
7 litros máximo
7 litros no máximo
7 litri massimo
7 Liters maxi

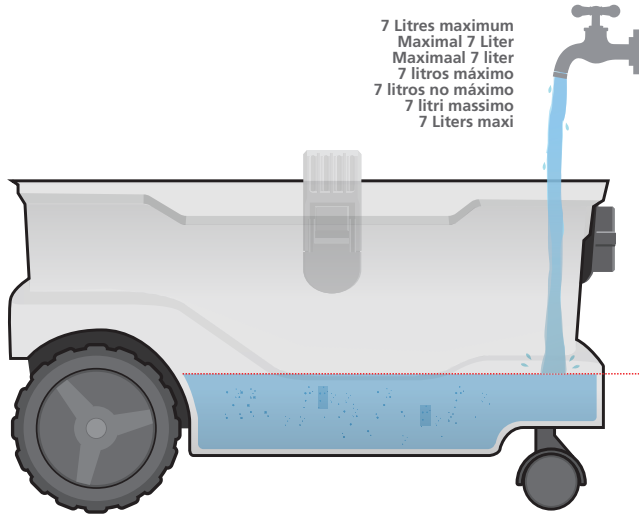

Max level

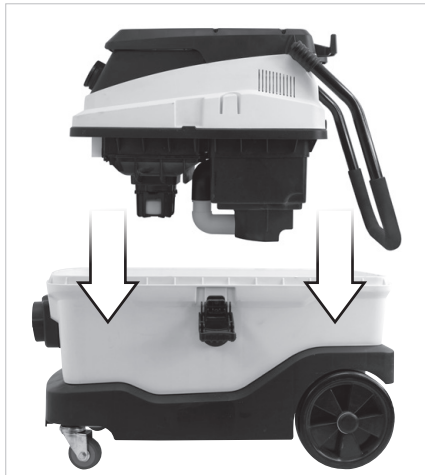
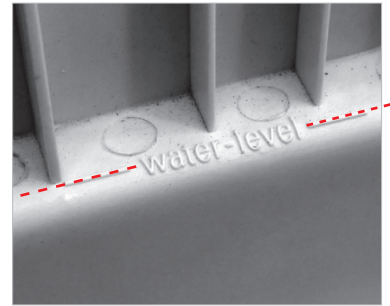
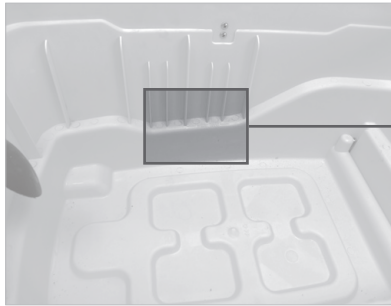

Mette en place le tuyau coudé et son support pour l'usage d'une aspiration multifiltre. (particules fines : plâtre, béton, ...)

Das Winkelrohr und seine Halterung für die Verwendung eines Mehrfilter-Saugers montieren. (feine Partikel: Gips, Beton, ...)

Monteer de kniestuk en de steun voor het gebruik van een multi-filteraanzuiging. (fijne deeltjes: gips, beton, ...)

Montar el tubo acodado y su soporte para el uso de una aspiración multifiltro. (partículas finas: yeso, hormigón, ...)

Monte o tubo em cotovelo e seu suporte para a utilização de uma sucção multifiltro. (partículas finas: gesso, concreto, ...)

Montare il tubo a gomito e il suo supporto per l'utilizzo di un'aspirazione multifiltro. (particelle fini: intonaco, cemento, ...)

Remove this part for dust extraction only

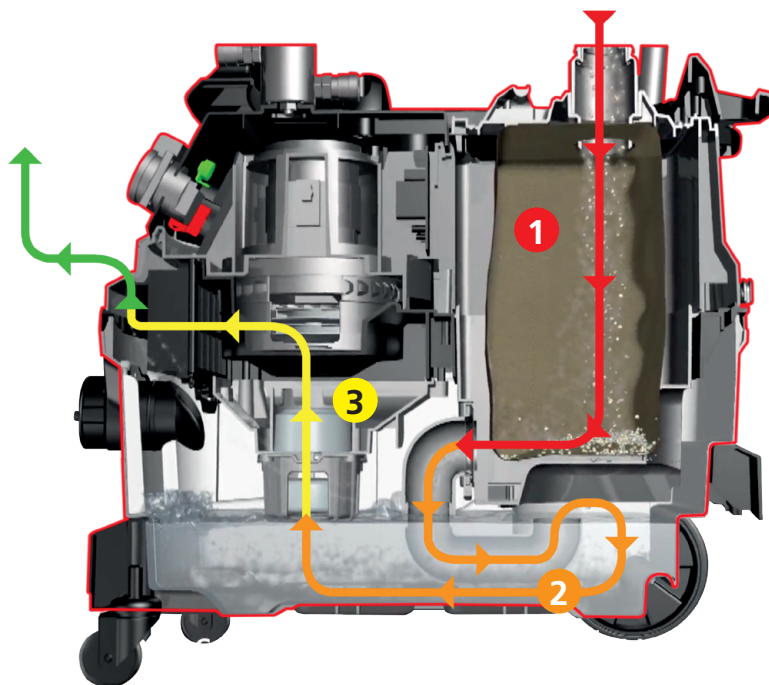

- 1** 1er niveau de filtration : sac à poussières :
Retire les particules fines (PM 2,5)
1st filtration level: dust bag:
Removes fine particles (PM 2.5)
- 2** 2ème niveau : bac à eau :
Retire les particules très fines (PM 1,0)
2nd level: water tank:
Removes fine particles (PM 1.0)
- 3** 3ème niveau : Filtre HEPA
Retire les particules ultrafines (PM 0,1)
3rd level: HEPA filter
Removes ultrafine particles (PM 0.1)

Aspiration particules fines uniquement (plâtre, béton)

Nur feine Partikel absaugen (Putz, Beton)
Alleen afzuiging van fijne deeltjes (gips, beton)
Succión solo de partículas finas (yeso, hormigón)
Succión apenas de partículas finas (gesso, concreto)
Aspirazione solo di particelle fini (intonaco, calcestruzzo)
Suction of fine particles only (plaster, concrete)

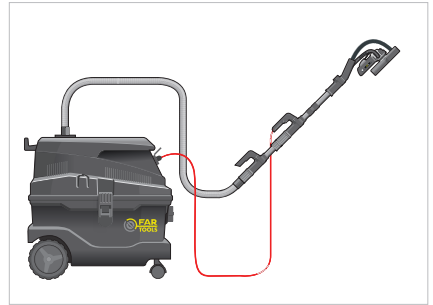
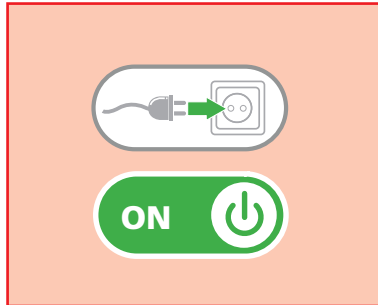

**2000 W
MAX**

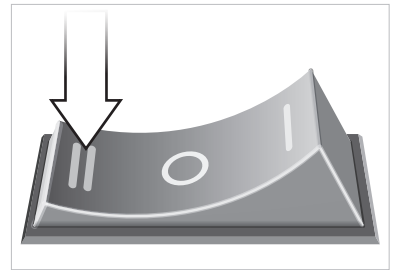
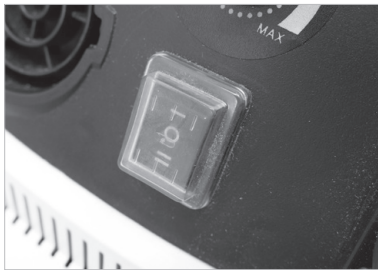

08



Aspiration eau et poussières uniquement

*Wasserabsaugung und nur Staub
Waterafzuiging en alleen stof
Aspiración de agua y solo polvo
Sucção de água e somente poeira
Aspirazione dell'acqua e solo polvere
Water suction and dust only*

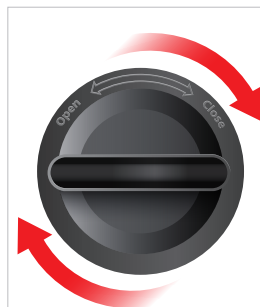
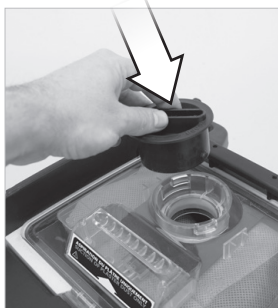
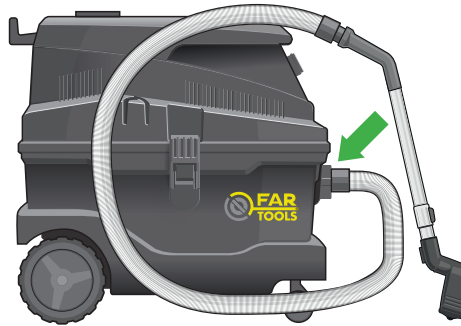

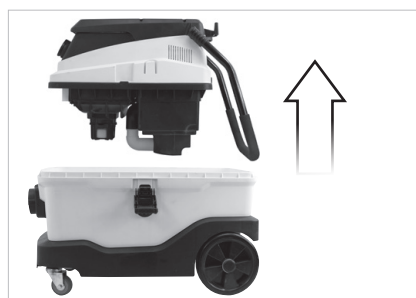
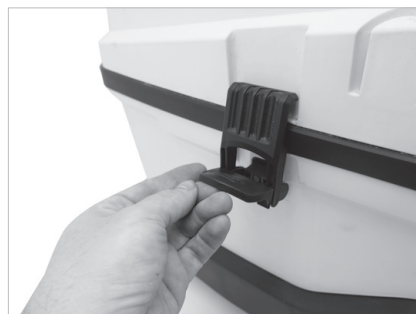
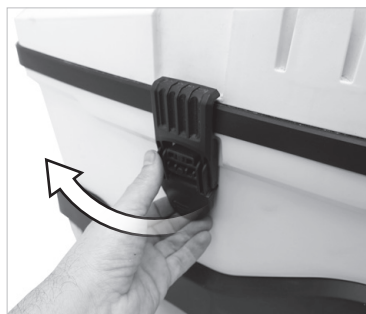

Avant d'installer le sac à poussières, s'assurer qu'il ne reste pas d'eau dans le fond du bac de l'aspirateur !
 Stellen Sie vor dem Einsetzen des Staubbeutels sicher, dass sich kein Wasser mehr im Boden des Staubsaugers befindet!
 Zorg ervoor dat er geen water op de bodem van de stofzuiger zit voordat u de stofzak installeert!
 Antes de instalar la bolsa para el polvo, asegúrese de que no quede agua en el fondo de la aspiradora.
 Antes de instalar o saco de pó, certifique-se de que não há água no fundo do aspirador!
 Prima di installare il sacchetto per la polvere, assicurarsi che non sia rimasta acqua sul fondo dell'aspirapolvere!
 Before installing the dust bag, make sure there is no water left in the bottom of the vacuum cleaner!

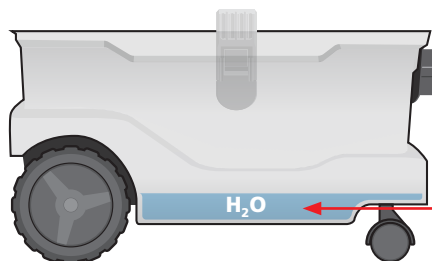

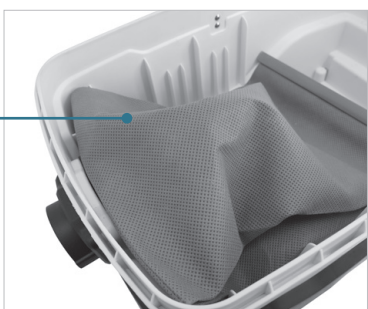
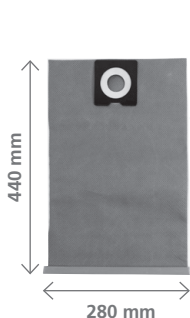

Ref. 101858

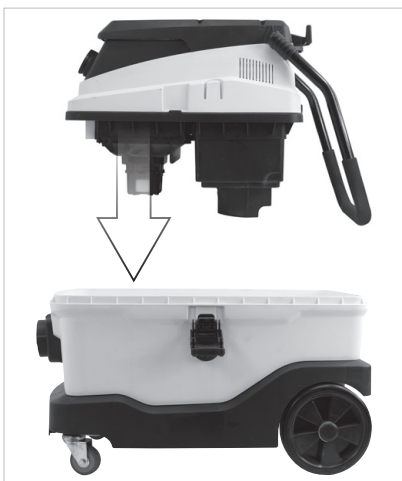
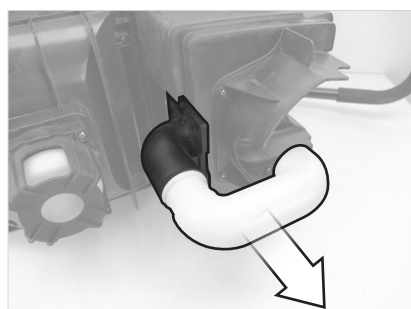
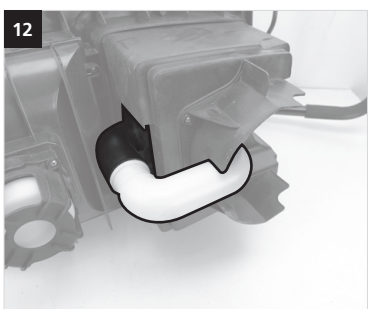

Retirer le tuyau coudé et son support pour l'usage du sac à poussières dans la cuve !

Entfernen Sie das Krümmerrohr und seine Halterung aus dem Staubebeutel im Tank!
 Haal het kniestuk en zijn steun voor gebruik uit de stofzak in de tank!
 ¡Retire el tubo acodado y su soporte para su uso de la bolsa de polvo en el tanque!

Remova o cotovelo e seu suporte para usar o saco de pó no tanque!
 Rimuovere il tubo a gomito e il suo supporto per l'uso dal sacchetto per la polvere nel serbatoio!

Remove the elbow pipe and its support for use from the dust bag in the tank!



Ref. 101857

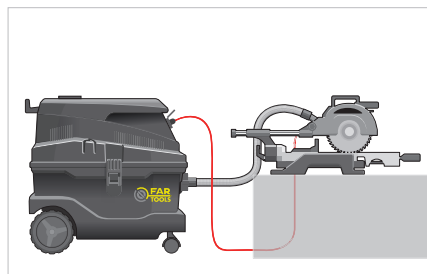

Fonctionnalité de la machine
Functions of the machine

E



5 s

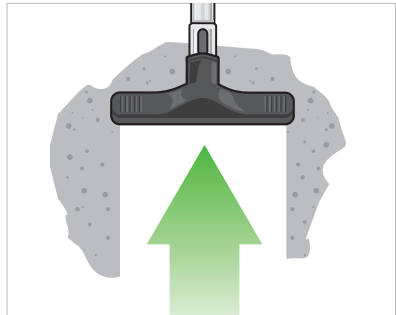
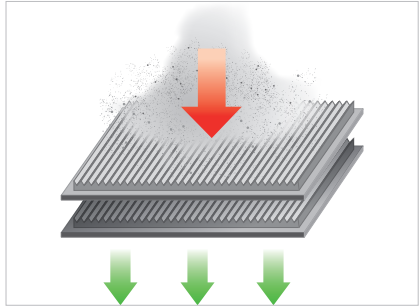
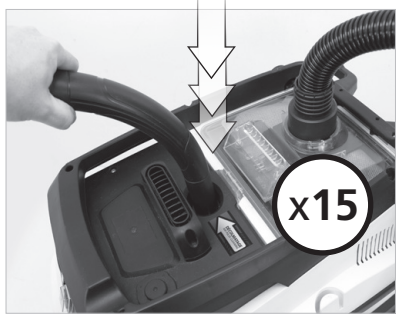
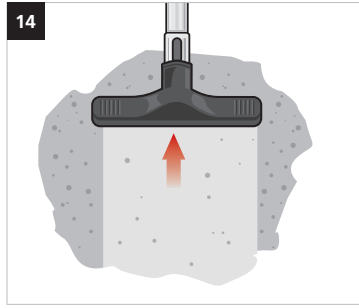

Fonctionnalité de la machine
Functions of the machine

E

15

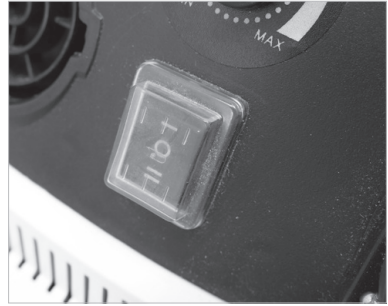
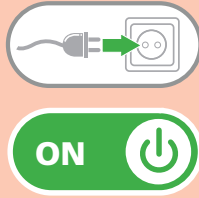

Démarrage instantané
Sofortiger Start
Onmiddellijke start
Inicio instantáneo
Desligamento atrasado
Inizio istantaneo
Instant start

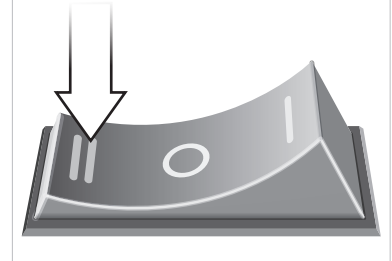
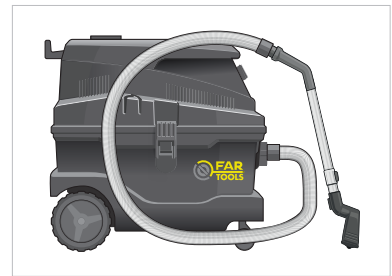
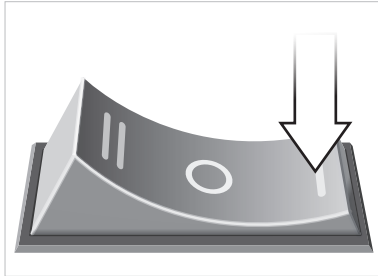

**2000 W
MAX**

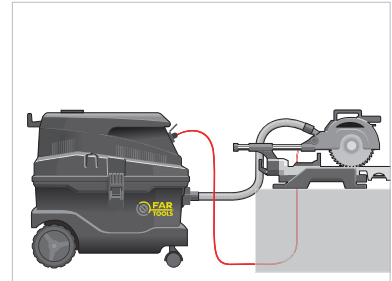
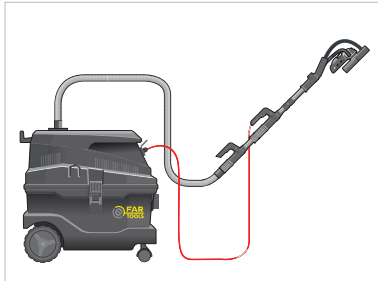

Démarrage instantané
Arrêt différé en 10 secondes
Onmiddellijke start
Vertraagde uitschakeling
in 10 seconden
Inicio instantáneo
Apagado retrasado en 10 segundos
Desligamento atrasado
em 10 segundos
Inizio istantaneo
Arresto ritardato in 10 secondi
Instant start
Delayed shutdown in 10 seconds

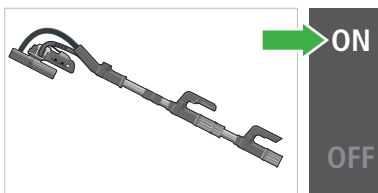

Fonctionnalité de la machine
Functions of the machine

E

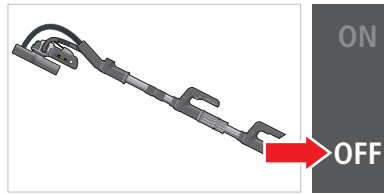

Arrêt différé en 10 secondes
Vertraagde uitschakeling in 10 seconden
Apagado retrasado en 10 segundos
Desligamento atrasado em 10 segundos
Arresto ritardato in 10 secondi
Delayed shutdown in 10 seconds



eau uniquement
Wasserabsaugung
Waterafzuiging
agua
água
acqua
Water only

16



16
Ref. 101856

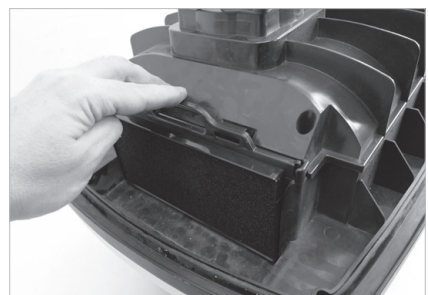
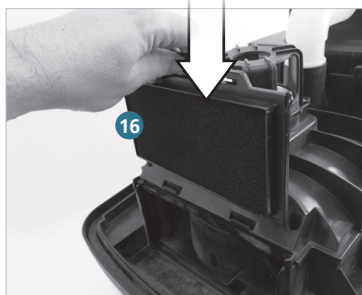

Fonctionnalité de la machine
Functions of the machine

E

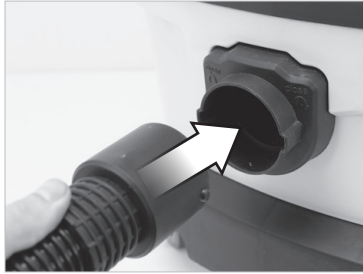

- A** Bouchon flotteur
Vlotter stopper
Float stopper
Tapón del flotador
Float rolha
Float stopper
- B** Entrée d'air - accès au filtre
Luchtinlaat - toegang filter
Entrada de aire - acceso al filtro
Entrada de ar - de acesso ao filtro
Air inlet - filter access

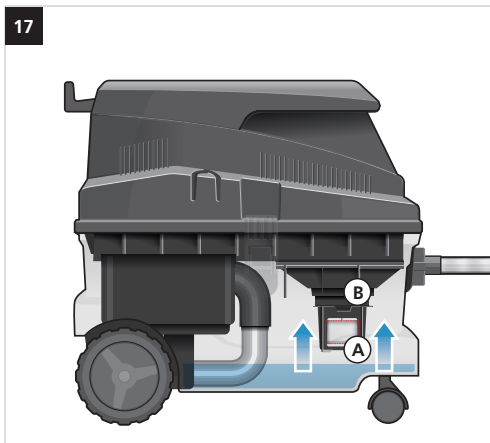

Mettre en place le tuyau coudé et son support pour l'usage d'une aspiration multifiltre. (particules fines : plâtre, béton, ...)

Das Winkelrohr und seine Halterung für die Verwendung eines Mehrfilter-Saugers montieren. (feine Partikel: Gips, Beton, ...)

Monteer de kniestuk en de steun voor het gebruik van een multi-filteraanzuiging. (fijne deeltjes: gips, beton, ...)

Montar el tubo acodado y su soporte para el uso de una aspiración multifiltro. (partículas finas: yeso, hormigón, ...)

Monte o tubo em cotovelo e seu suporte para a utilização de uma sucção multifiltro. (partículas finas: gesso, concreto, ...)

Montare il tubo a gomito e il suo supporto per l'utilizzo di un'aspirazione multifiltro. (particelle fini: intonaco, cemento, ...)

Remove this part for dust extraction only

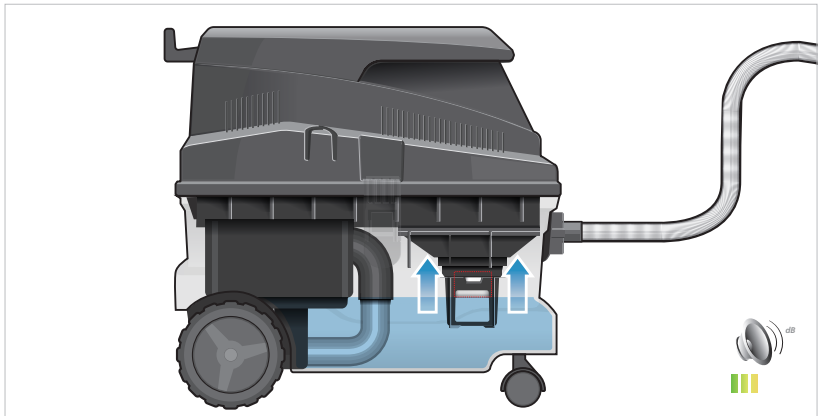

Fonctionnalité de la machine
Functions of the machine

E

Attention ! lorsque le flotteur atteint le haut, le bruit du moteur augmente fortement mais celui ci ne s'arrête pas ! Il est recommandé de stopper l'aspirateur immédiatement et de procéder à la vidange de la cuve !

Kijk Uit! wanneer de vlotter voor de top bereikt, motorgeluid sterk toeneemt, maar dit houdt niet op! Het wordt aanbevolen om onmiddellijk te stoppen stofzuigen en ga verder met de tank af te tappen!

Cuidado! cuando el flotador llega a la cima, el ruido del motor aumenta bruscamente, pero esto no se detiene! Se recomienda dejar pasar la aspiradora inmediatamente y proceder a drenar el tanque!

Cuidado! quando o flutuador atinge o topo, o ruído do motor aumenta acentuadamente, mas isso não para! Recomenda-se a interromper a aspiração imediatamente e prosseguir para drenar o tanque!

Attenzione! quando il galleggiante raggiunge la parte superiore, il rumore del motore aumenta bruscamente, ma questo non si ferma! Si raccomanda di interrompere l'aspirazione immediatamente e procedere svuotare il serbatoio!

Watch Out! when the float reaches the top, engine noise increases sharply but this does not stop! It is recommended to stop vacuuming immediately and proceed to drain the tank!

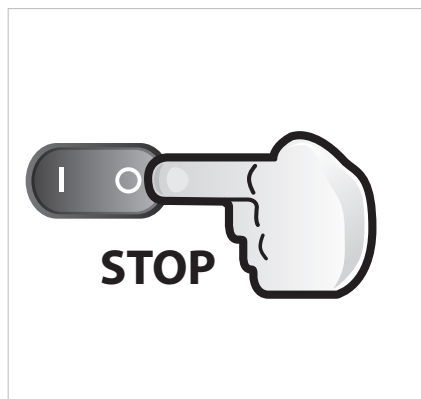
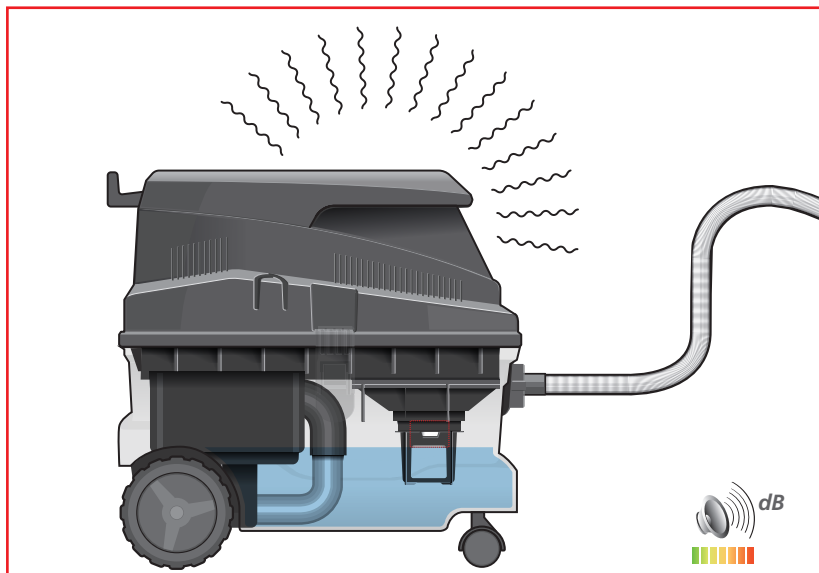

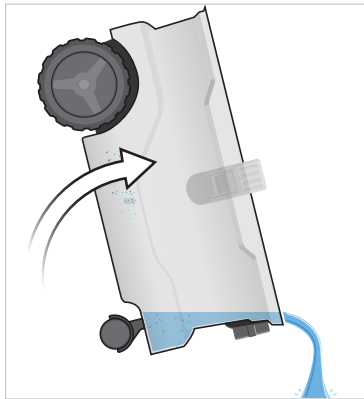
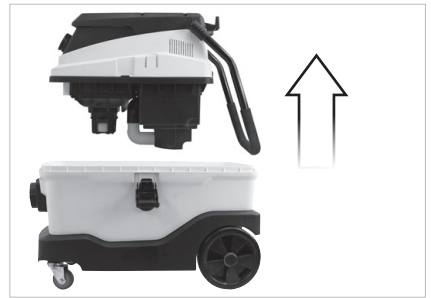
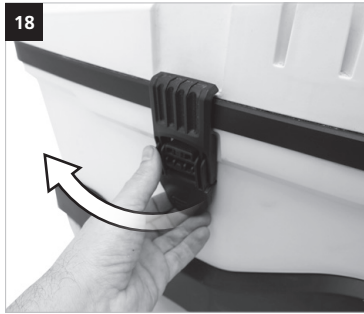

Fonctionnalité de la machine
Functions of the machine

E

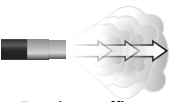
Fonction souffleur
 Gebläsefunktion
 Blower functie
 Función de soplador
 Função de soprador
 Funzione ventilatore
 Blower function



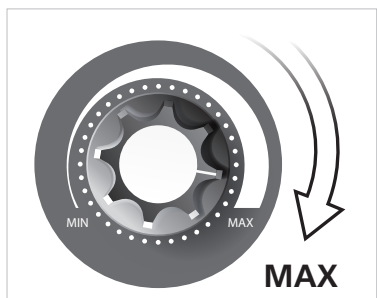
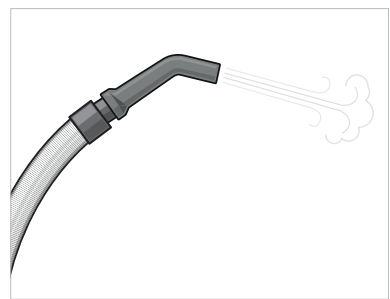
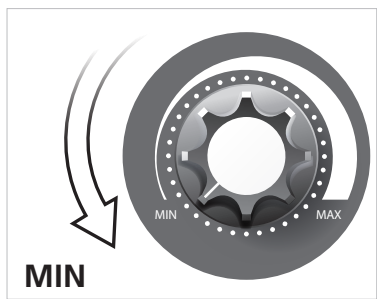
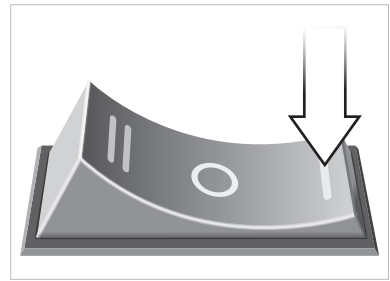

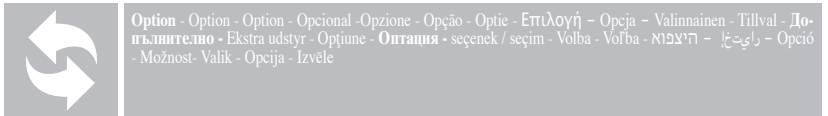
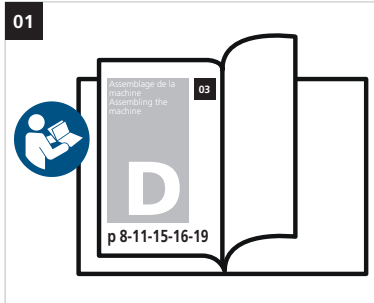
Option - Option - Option - Opціона - Opzione - Опція - Opție - Επιλογή - Opція - Valinnainen - Tillval - Дополнительно - Ekstra udstyr - Opřine - Оптація - seçenek / seçim - Volba - Volba - מוצר נבחר - رایج - Opció - Možnost - Valik - Opcija - Izvele

101856 :

Filtere cartouche mousse pour eaux
Schuimpatroonfilter voor water
Filtro de cartucho de espuma para agua
Filtro de cartucho de espuma Para água
Filtro a cartuccia in schiuma per l'acqua
Foam cartridge filter for water



101857 :

Filtere cartouche papier pour poussières
Papieren patroonfilter voor stof
Filtro de cartucho de papel para el polvo
Filtro de cartucho de papel para poeira
Filtro a cartuccia di carta per la polvere
Paper cartridge filter for dust



101858 :

Sac toile pour cuve
Stofzak
Bolsa de polvo
Saco de pó
Borsa antipolvere
Dust bag

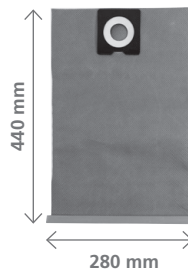

101859 :

Sac à poussières Spécial particules fines
Speciale stofzak
fijne deeltjes
Bolsa de polvo especial partículas finas
Saco de pó especial partículas finas
Sacco polvere speciale particelle fini
Special dust bag
fine particles

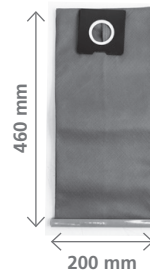

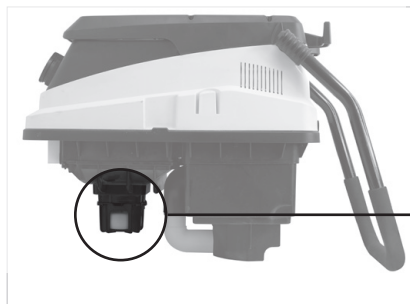

Toujours veiller à ce que le flotteur soit «libre» et ne soit pas gêné par des débris (feuilles, gravats) afin de pouvoir remplir sa fonction
Stellen Sie immer sicher, dass der Schwimmer «frei» ist und nicht durch Ablagerungen (Blätter, Schutt) behindert wird, um seine Funktion erfüllen zu können.

Zorg er altijd voor dat de vlotter «vrij» is en niet gehinderd wordt door afval (bladeren, puin) om zijn functie te kunnen vervullen.

Asegúrese siempre de que el flotador esté «libre» y no esté obstaculizado por detritos (hojas, escombros) para poder cumplir su función.



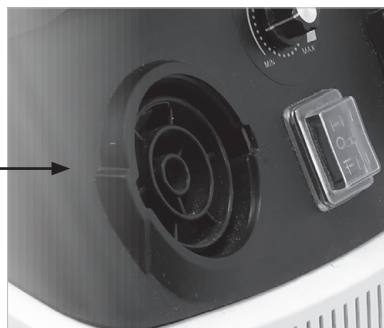

Certifique-se sempre de que o flutuador está «livre» e não está atrapalhado por detritos (folhas, entulho) para poder cumprir a sua função.

Assicurarsi sempre che il galleggiante sia «libero» e non sia intralciato da detriti (foglie, pietrisco) per poter svolgere la sua funzione.

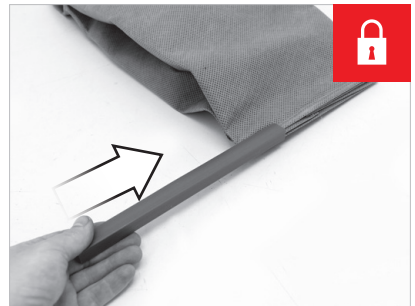
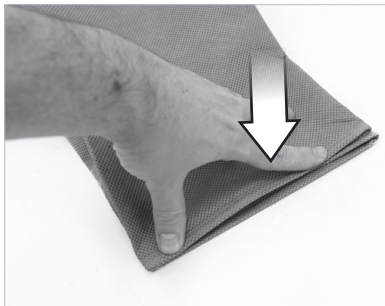
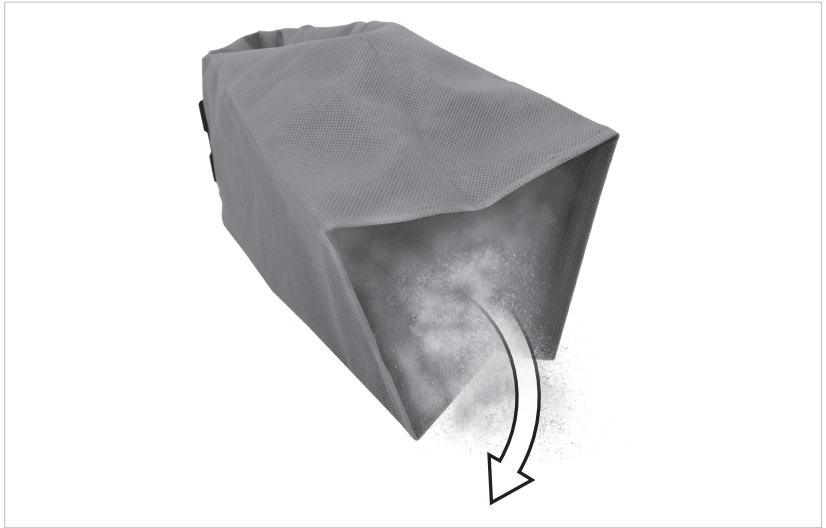
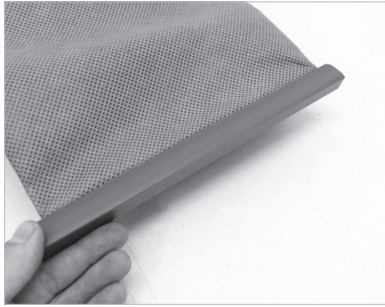
Always ensure that the float is «free» and is not hampered by detritus (leaves, rubble) in order to be able to fulfill its function.







| | | | |
|---|--|--|----------------------|
|  | <p>Tension et fréquence assignée: Nominal frequency and power: Spannung und Frequenz: Tensión y frecuencia fijada: Tensione e frequenza assegnata: Tensão e frequência fixa: Aangewezen spanning en frequentie: Ονομαστική τάση και συχνότητα: Napięcie i częstotliwość przydzielona: Jännite ja määrittäytyäsuus: Angiven spänning och frekvens: Anført spænding og frekvens: Tensiune și frecvență de lucru:</p> | <p>Заданное напряжение и частота: Tahsis gerilimi ve frekans: Stanovené napětí a frekvence: Stanovené napätie a frekvencia: מתח ותדר מוקצב. الغلطية والذبذبة المبرمجة. Névleges feszültség és frekvencia: Napetost in določena frekvenca: Консумирано напрежение и честота : Määratud pinge ja sagedus Nustatyta įtampa ir dažnis Noteiktāis spriegums un frekvence. Napon i nazivna frekvencija:</p> | 230 V ~ 50 Hz |
|  | <p>Puissance assignée: Nominal power: Leerlaufdrehzahl: Potencia fijada: Potenza assegnata: Potência assinada: Onbelast toerental: Ονομαστική ισχύς : Prędkość na biegu jałowym: Teho: Angiven effekt: Anført styrke: Putere de lucru:</p> | <p>Заданная мощность: Tahsis edilen güç: Stanovený příkon: Predpísaný výkon: כוח מוקצב. القدرة المبرمجة. Névleges teljesítmény : Določena jakost: Консумирана мощност: Määratud võimsus. Nustatyta galia Noteiktā jauda Nazivna snaga:</p> | 1600 W |
|  | <p>Poids : Weight : Gewicht : Peso : Peso : Peso : Gewicht : Βάρος : Masa : Paino : Vikt : Vægt : Greutate :</p> | <p>Вес : Ağırlık : Hmotnost : Hmotnosť : משקל العوزن. Súly : Teža : Тегло : Raskus Svoris Svars Težina:</p> | 14,5 kg |
|  | | 10-20 kPa | |
|  | <p>Conformité européenne Conforms to EC standards : CE-Konformität : Cumple con las directivas CE : Conforme alle norme CE : Conforme às normas CE : Voldoet aan de EG-normen : Συμφώνο με τα πρότυπα Zgodność z normami CE : EU-standardien mukainen : EU-standardien mukainen : Overholder EU standarderne : Conform cu normele europene:</p> | <p>соответствие европейским стандартам: Avrupa uygunluk : evropská shoda : európska dohoda : התאמה לתקנים האירופיים مطابق للمواصفات الأوروبية. evropska ustreznost : európai megfeleléség : Съответствие с европейските норми : Euroopa Liidu vastavusmärk Europinių normų atitikima Atbilstība Eiropas standartiem Evropska sukladnost</p> | X |

| | | | |
|---|---|---|---|
|  | <p>Porter des lunettes de sécurité : Wear protective eyewear : Schutzbrille tragen : Llevar puestas gafas protectoras : Portare de gli occhiali di sicurezza : Utilizar óculos de segurança : Draag een veiligheidsbril : Φορέστε Προστατευτικά γυαλιά : Zakładać okulary ochronne : Käytä suojalaseja : Använd skyddsglasögon : Der skal benyttes sikkerhedsbriller : Purtati ocelari de protectie :</p> | <p>Наденьте защитные очки : Güvenlik gözlükleri takın : Používejte bezpečnostní brýle : Noste ochranné okuliare : תווחיטו יפקשמ ביכרהל אנ חבל נזפארט וקאי. Viseljen védőszemüveget : Nositi zaščitna očala : Да се използват защитни очила : Kandke kaitseprille Nešioti apsauginius akinius Valkät aizsargbrilles Nositi zaštitne naočale:</p> | X |
|---|---|---|---|

| | | | |
|---|---|--|---|
|  | <p>Porter un masque anti-poussière : Wear a dust mask : Staubschutzmaske tragen : Llevar puesta una careta de protección contra el polvo : Indossare una mascherina anti-polvere : Utilizar uma máscara anti-poeira : Draag een stofmasker : χρήση προστατευτική μάσκα : Zakładać maskę przeciwpyłową Käytä pölysuojust : Bär mask mot damm : Der skal benyttes beskyttelsesmaske mod støv: Purtati mască anti-praf :</p> | <p>Наденьте респиратор : Toza karşı maske takın : Používejte masku proti prachu : Noste ochrannú masku proti prachu : קבא דגן הכסמ שובחל אנ ליס קנאע חזאז ללדגבאר. Viseljen porvédő maszkot Nositi zaščitno masko proti prahu: Да се използва защитна маска : Kandke tolmumaski. Dėvėti respiratorių Valkät aizsarg masku pret putekļiem Nositi masku za zaštitu od prašine:</p> | X |
|---|---|--|---|

| | | | |
|--|--|--|---|
|  | <p>Porter une protection auditive : Wear hearing protective equipment: Gehörschutz tragen: Llevar puesta una protección auditiva: Portare una protezione uditiva: Utilizar uma protecção auditiva: Draag gehoorbeschermers: Φορέστε Προστατευτικά ακουστικά Zakładać słuchawki ochronne Käytä kuulosuojaimia: Bär hörselskydd: Der skal benyttes høreværn: Purtati căști de protectie auz:</p> | <p>наденьте средства звуковой защиты: İşitsel koruma aleti takın: Používejte ochranu sluchu: Noste ochranné sluchadlá: יש ל הרכיב הגנת שמיעה ליס חוזה חזיש אלחריגי Viseljen fülvédőt Nositi zašito ušes: Да се използва слухови защитни средства: Kandke kõrvakaitset Nešioti apsaugą nuo triukšmo Valkät dzirdes aizsarglīdzekli Nositi štitnike protiv buke:</p> | X |
|--|--|--|---|

| | | | |
|---|---|--|---|
|  | <p>Porter des gants : Use rubber gloves : Schutzhandschuhe tragen : Llevar guantes de protección : Indossare i guanti di protezione : Utilizar luvas de protecção : Draag veiligheidshandschoenen : χρήση προστατευτικών γαντιών : Używać rękawic ochronnych : Käytä suojakäsineitä : Använd skyddshandskar : Der skal benyttes handsker : Purtati mănuși :</p> | <p>Наденьте перчатки : Eldiven takın : Noste rukavice : Noste rukavice : תופכ שובבל אנ ליס קפאזאז. Viseljen kesztyű t Nositi rokavice: а се използват предпазни ръкавици : Kandke kindaid Müvėti pirštines Valkät cimdus Nositi zaštitne rukavice:</p> | X |
|---|---|--|---|

| | | | |
|---|--|--|----------|
|  | <p>Lire les instructions avant usage : Read the instructions before use : Vor Einsatz des Geräts Anweisung lesen : Léase las instrucciones antes de usar : Leggere le istruzioni prima dell'uso : Ler as instruções antes da utilização : Lees voor het gebruik de instructies : Διαβάστε τις οδηγίες χρήσης : Zapoznać się instrukcją przed użyciem : Lue ohjeet ennen käyttöä : Läs anvisningarna före användning : Læs instruktionerne før brug : Înainte de utilizare, citiți instrucțiunile :</p> | <p>Внимательно прочитайте следующие инструкции : Kullanmadan talimatları okuyunuz : Pozorně si přečtete následující pokyny : Pred použitím si prečítajte pokyny : זרם הילופי اقرأ التعلیمات قبل الاستخدام. használat előtt olvassuk el az utasítást : Pred uporabo preberite ustrezna navodila Прочетете указанията за употреба : Enne kasutamist lugege instruksiooni Prieš naudojimą perskaityti instrukciją izlasīt instrukcijas pirms lietošanas Pročitati upute prije uporabe:</p> | X |
|---|--|--|----------|

| | | | |
|---|--|---|----------|
|  | <p>Danger : Danger : Gefahr : Peligro : Pericolo : Perigo : Gevaar : Κινδύος : Niebezpieczeństwo : Vaara : Fara : Fare : Pericol :</p> | <p>Опасно : Tehlike : Nebezpečí : Nebezpečnost : סכנה. خطر. Veszély : Nevarnost: Опасност : Oht Pavojus Bistamība Opasnost:</p> | X |
|---|--|---|----------|

| | | | |
|---|--|--|----------|
|  | <p>Soumis à recyclage Subjected to recycling Sujeto a reciclaje Sottoposti a riciclaggio Sujeitos à reciclagem Não deite no lixo : Niet wegwerpen : Μην την πετάτε : Nie wyrzucas : Älä heitä pois luontoon : Batteriet får inte kastas : Bortkast det ikke: Nu le auncati :</p> | <p>Не выбрасывайте в мусорный ящик Atmayınız : Nevyhazujte je do běžného odpadu : Neodhadzovat : אין לזרוק סוללות فل ترمها بلذا في القمامة. ne mečite! Ne odvržite ga/jih vstran : Не го изхвърляйте : Ärge visake seda minema : Nemétykíte : Nemest : Podvrgnuto recikliranju</p> | X |
|---|--|--|----------|

Recyclage des déchets :

Les outils, accessoires et leur emballages doivent suivre une voie de recyclage adaptée. Conformément aux directives Européenne 2012/19/UE et 2006/66/CE, les composants d'un produit doivent être séparés, collectés, recyclés ou éliminés en conformité avec les réglementations environnementales en vigueur. Les appareils, batteries, huiles, emballages devront être déposés dans les systèmes d'élimination des déchets spéciaux tels que déchetteries. Renseignez-vous auprès de votre commune pour connaître l'organisme le plus proche à même de retraiter ou de collecter ces déchets.

| | | | |
|---|---|--|----------|
|  | <p>Recyclable, soumis au tri sélectif Recyclable, subject to recycling Recyclingfähige, unterliegen Recycling Reciclables, sujetos a reciclaje Riciclabili, soggetti a riciclaggio Recicláveis, sujeito à reciclagem Recycleerbare, onderworpen aan recycling Ανακυκλώσιμες συσκευασίες που υπόκεινται σε κύκλωμα Opakowanie nadaje się do recyklingu podlegają recyklingu Kierrätettävien pakkausten kohteena kierrätys Återvinningsbara förpackningar omfattas återvinning Рециклиращи се опаковки подлежат на рециклиране Genanvendelig underlagt genbrug</p> | <p>Reciclabile sub rezerva reciclare Повторно опаковка подлежат вторичной переработке Geri dönüşüm Geri dönüştürülebilir ambalaj konusu Recyklovateľné podliehajúci recyklácii Recyklovateľné podliehajúce recyklácii רוחמל ורוחמל היזראח אשונ ريدينلا خايعال عيشين ريدينلا خايعال تلبانلا فويلي تبتال و توب يندا Újrahasznosítható csomagolás alá újrahasznosítás Reciklirati predmet recikliranja Pakendite suhtes ringlussevõtu Pärsträdajams iepakojuoms otrreizējai pārstrādei Perdirbamų taikomos perdirbimo Može se reciklirati, podložno selektivnom sortiranju</p> | X |
|---|---|--|----------|

| | | |
|---|---|-------------|
|  | <p>Capacité cuve : Tank capacity: Volumen der Wanne : Capacidad depósito : Capacità vasca : Capacidade da fina : Capaciteit van de kuip : χωρητικότητα δεξαμενή : Pojemność zbiornika : Säiliön vetävyys : Cisternkapacitet :</p> <p>beholderkapacitet : capacitate cuvă: объем бака : Kap kapasitesi : kapacita nádoby : obsah nádrže : מידות סמרות. سرعة التخزين a kád kapacitása : kapaciteta kadi : Капацитет на корпуса :</p> | <p>35 L</p> |
|---|---|-------------|

| | | |
|---|---|----------------|
|  | <p>Diamètre tuyau : Tube diameter : Schlauchdurchmesser : Diámetro tubo : Diametro tubo : Diámetro do tubo : Diameter van de buis : Διάμετρο σωλήνα : Srednica przewodu : Putken halkaisija : Rördiameter :</p> <p>rørdiameter : diametru furtun : диаметр трубы Boru çapı : průměr trubky : priemer hadice : קוטר צינור قطر الأنبوب. a cső átmérője : premer cevi : Диаметър на тръбата :</p> | <p>Ø 35 mm</p> |
|---|---|----------------|

| | | |
|---------------------|--|-----------------|
| <p>IP X4</p> | | <p>X</p> |
|---------------------|--|-----------------|

MF 35PLASTER

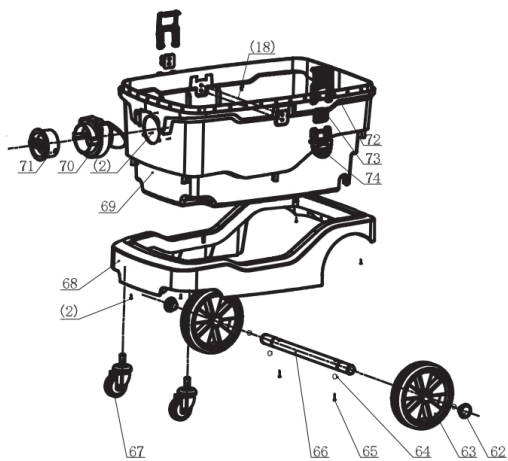
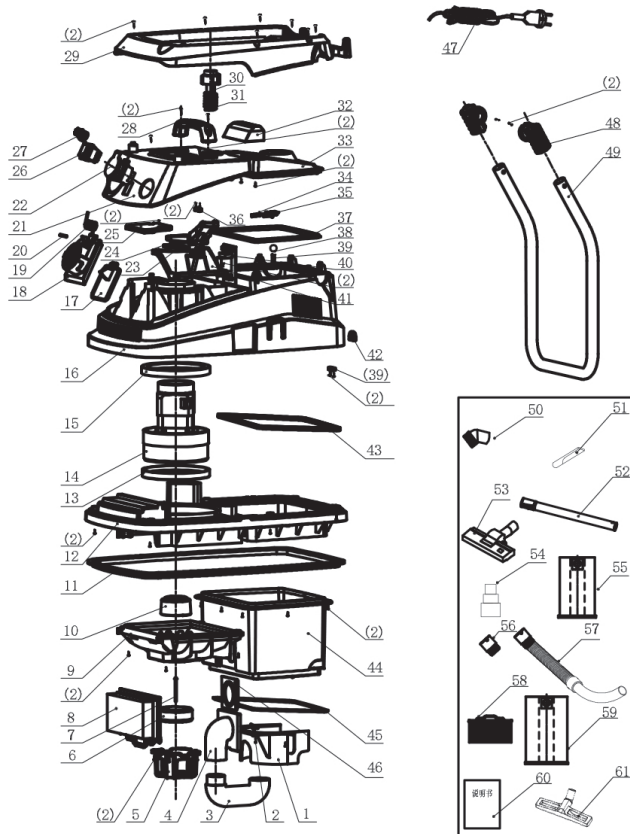

DECLARATION DE CONFORMITE
 VERKLARING VAN OVEREENSTEMMING
 DECLARACION DE CONFORMIDAD
 DICHIARAZIONE DI CONFORMITA
 KONFORMITÄSERKLÄRUNG
 DECLARATION CONFORMITY
 DECLARAÇÃO DE CONFORMIDADE
 DEKLARACJA ZGODNOSCI Z NORMAMI
 OM ÖVERENSSTÄMMELSE
 VAATIMUSTENMUKAISUUSVAKUUTUS
 ÖVERENSSTEMMELSESERKLÆRING
 Δήλωση συμμόρφωσης/συμμόρφωσης

DECLARAȚIE DE CONFORMITATE
 VYHLÁSENIE ZHODY
 Декларация соответствия
 תצהיר תואמת
 Uygunluk beyanı
 التصريح بالمتطابق
 PROHLÁŠENÍ SHODY
 EGYZESÉGI NYILATKOZAT
 Декларация за съответствие с нормите
 IZJAVA O SKLADNOSTI
 DEKLARACIJA
 ATITIKTIES DEKLARACIJA
 KINNITUS
 IZJAVA O SUKLADNOSTI

Le soussigné,
 Ondergetekende,
 Der Unterzeichner,
 O abaixo assinado,
 Undertecknad,
 Долуподписаният
 Undertegnede
 Subsemnatul,
 Я, нижеподписавшийся,
 Imzalıyan,
 Níže podepsány,
 Toliau pasirašęs

Personne autorisée à constituer
 le dossier technique :
 Ronan GUILLIOT



FAR GROUP EUROPE
 192, Avenue Yves Farge
 37700 St. Pierre-des-Corps
 FRANCE

El suscrito,
 Il sottoscritto,
 The undersigned,
 Nínej podpísany
 Allekirjoittanut,
 Ουπερσγεγραμμένος
 Nížšie podpísany
 מתחת התיבות,
 الموقّع أدناه
 Alulírott,
 Podpisani,
 Apakšā parakstījies
 allakirjutanu
 Dolje potpisani,

Déclare par la présente que,
 Verklaart hiermede dat,
 Erklärt hiermit daß,
 Declara pela presente que,
 Förklarar härmed att
 Заявлява с настоящото
 erklærer hermed, at
 Declar prin prezenta că,
 настоящим подтверждаю, что
 Mevcut belgeyle beyan ediliyor ki,
 timto prohlašuje, že,
 Pareiškia, kad,

Declara por la presente, que,
 Dichiare che,
 Declares that,
 OÖwiadcza niniejszym, że
 Ilmoitetaan täten että,
 Δηλώνω με την Παράστα
 týmto vyhlášu je, že
 מצהיר בה כי
 يصرح إستنادا على ذلك
 kijelentem, hogy a készülék izjavlja da,
 Pareiškia, kad,
 Ar šo apļiecina, ka,
 Kinnitab, et
 Izjavljuje u ovom dokumentu da je

*Aspirateur à décolmatage / Decluttering vacuum cleaner / Decluttering Staubsauger / Aspiradora desordenada /
 Aspirapolvere di decluttering / Aspirador decluttering / Ophelderende stofzuiger / Ηλεκτρική σκούπα απολύμανσης / Odkuracz do odpryskania /
 Decluttering pölyn imuri / Decluttering vysávač / Прахосмукачка с дефлуири / Declurende støvsuger / Aspirator de decluttering / Захвалмаение пылесоса /
 Decluttering elektrikli stipinger / Declutajıcı vysavač / Decluttering vysávač / שאוב אבק התורה / מכسنة كهربائية / Decluttering porszívó / Decluttering sesalnik /
 Vaakum tolmuiemeja / Pramoninis plaušanas dulkių siurblys / Vaakum tolmuiemeja / Utsini usisavac*

code

FARTOOLS / 101213 / MF 35PLASTER / JN501PT

Est conforme et satisfait aux directives et normes CE,
 In overeenstemming is met en Voldoet aan EG richtlijnen,
 Den folgenden EU-Bestimmungen entspricht,
 Respeita e está em conformidade com as normas CE,
 Överensstämmer med och uppfyller EG-standarder,
 Съответства и отговаря европейските норми
 Er i overensstemmelse med og overholder EU
 standarderne
 Este conform și satisface normele CE
 полностью соответствует и удовлетворяет
 требованиям стандартов ЕС
 CE şartlara uygundur,
 odpovídá normám ES.
 Atitinka ir atitinka EB direktyvas ir standartus,

Cumple con la directivas de la CE,
 E conforme alle direttive CEE,
 Complies with the EEC directives and standards,
 Odpowiada normom UE,
 Täyttää EU-vaatimukset,
 Είναι συμμόρφωσο και ανταποκρίνεται στα Προτάματα CE
 zodpovedá normám ES.
 מתאים ועונה לתקני CE
 بیان الجواز مطابق و يلبي معايير مجموعة الدول الأوروبية
 kielégíti a CE szabványok előírásait.
 Je v skladu z in izpolnjuje norme Evropske skupnosti.
 Atbilst un atbilst EK direktīvas un standartus,
 Vastab ja vastab EU direktiividele ja standartiteile,
 Sukladan i ispunjava direktive i standarde CE,

2014/30/EU 2014/35/EU 2011/65/EU 2015/863/EU

EN62233:2008
 EN60335-1:2012+A11:2014+A13:2017+A1:2019+A2:2019+A14:2019
 EN60335-2-2:2010+A11:2012+A1:2013
 EN IEC 55014-1:2021
 EN IEC 55014-2:2021
 EN IEC 61000-3-2:2019+A1:2021
 EN 61000-3-3:2013+A1:2019+A2:2021

Ronan GUILLIOT,
 Directeur général
 17/11/2022
 Fait à St. Pierre-des-Corps

FAR TOOLS MF 35PLASTER 101213

230V-50Hz 1600 W 10-20 Kpa 35 L

Puissance totale : 3600 W. Puissance Maximum asservie : 2000 W

FAR GROUP EUROPE - 192, Avenue Yves Farge
37700 - St. Pierre-des-Corps - FRANCE
JN501PT

Serial number / numéro série :

Made in P.R.C.

Icons: Ear protection, Eye protection, Hand protection, Dust protection, CE mark, Warning triangle, No open flame, No sparks, No hot surfaces.

FAR TOOLS[®]

MF 35PLASTER 101213

DÉCOLMATAGE
AIR PULSE CLEANING

ASPIRATION PARTICULES FINES UNIQUEMENT
SUCTION OF FINE PARTICLES DUST ONLY

(Plâtre, béton,...) (Plaster, concrete,...)

MAX
2000 W

EAU & POUSSIÈRES
UNIQUEMENT
WATER AND DUST
ONLY

GARANTIE - WARRANTY



FR. GARANTIE

Cet outil est garanti contractuellement contre tout vice de construction et de matière, à compter de la date de vente à l'utilisateur et sur simple présentation du ticket de caisse. La garantie consiste à remplacer les parties défectueuses. Cette garantie n'est pas applicable en cas d'exploitation non conforme aux normes de l'appareil, ni en cas de dommages causés par des interventions non autorisées ou par négligence de la part de l'acheteur. La garantie ne s'applique pas sur les dommages causés par une défaillance de l'outil.

DE. GARANTIE

Die Garantiezeit für dieses Gerät in bezug auf Konstruktions- und Materialfehler beträgt lt. Vertrag bei Vorlage des Kassenbons. Die Garantieleistung besteht im Ersatz schadhafter Teile. Die Garantie erlischt bei einem Einsatz des Geräts, der nicht normentsprechend ist, bei Schäden, die auf unsachgemäße Eingriffe zurückzuführen sind bzw. bei Nachlässigkeit seitens des Käufers. Die Garantie erstreckt sich nicht auf Schäden, die auf Fehlfunktionen des Geräts zurückzuführen sind.

IT. GARANZIA

Quest' attrezzo è garantito per contratto contro qualsiasi difetto di costruzione e di materia, a partire dalla data di vendita all'utente e su semplice presentazione dello scontrino. La garanzia consiste nel sostituire le parti difettose. Questa garanzia non è applicabile in caso di sfruttamento non conforme alle norme dell'apparecchio, né in caso di danni causati da interventi non autorizzati o da negligenza da parte dell'acquirente. La garanzia non si applica ai danni causati da un'avaria dell'attrezzo.

EN. GARANTEE

This tool is guaranteed, in writing, against any defect in manufacture or parts from the date of sale, upon simple presentation of the sales slip. The guarantee is limited to the replacement of faulty parts. This guarantee is not applicable in the event of usage which is not conform with the intended usage of the apparatus, nor in the event of damage caused by unauthorised servicing or negligence on behalf of the purchaser. This guarantee does not apply to any damage caused by the failure of this tool.

ES. GARANTIA

Esta herramienta se garantiza contractualmente contra todo defecto de construcción y materia, a partir de la fecha de venta a l' usuario y sobre simple presentación del recibo de caja. La garantía consiste en sustituir a las partes defectu-

osas. Esta garantía no es aplicable en caso de explotación no conforme a las normas del aparato, ni en caso de daños causados por intervenciones no autorizadas o por negligencia por parte del comprador. La garantía no se aplica sobre los daños causados por un fallo del herramienta.

NL. GARANTIE

Dit gereedschap heeft een garantie tegen constructiefouten en materiaaldefecten, die geldig is vanaf de aankoopdatum door de gebruiker, op vertoning van de kassabon. De garantie betreft de vervanging van de defecte onderdelen. Deze garantie is niet van toepassing indien het apparaat niet volgens de normen gebruikt is, noch in geval van schade veroorzaakt door oneigenlijk gebruik of nalatigheid van de koper. De garantie is niet van toepassing op schade voortvloeiend uit een defect van het gereedschap.

PT. GARANTIA

Esta ferramenta tem uma garantia contratual contra qualquer defeito de construção e de material, a partir da data de venda ao utilizador e sobre simples apresentação do talão da caixa.. A garantia consiste em substituir as partes defeituosas. Esta garantia não é aplicável no caso de exploração não conforme às normas do aparelho, nem em caso de danos causados pelas intervenções não autorizadas ou por negligência da parte do comprador. A garantia não se aplica para os danos causados por uma falha da ferramenta.

EL. Εγγύηση

Το εργαλείο αυτό φέρει συμβατική εγγύηση για οποιούδηποτε ελαττωμα κατασκευής απ'ο την ημερομηνία Π'ωλησης στο χρ'ηση. με απλ'η Προσ'ομιση της απ'ο'οειξής αγορ'αζ. Η εγγύηση απ'οτελείται απ'ο την αντικατ'αοταση του ελαττωματικ'ου τμημ'ατων. Η Παρο'υσα εγγύηση οεν εφαρμ'οζεται σε Περ'ιπτωση χρ'ησης μη σ'ομ'φωνής με τα Πρό'οτυπα της συσκευ'ης. η σε Περ'ιπτωση ζημ'ιαζ Που Προκλ'ηθηκε απ'ο μη εγκεκριμ'ενη ΕΠ'εμβαση 'η απ'ο αμ'ελεα του αγοραστ'η. Η Εγγύηση"οεν εφαρμ'οζεται στις ζημ'ιες Που Προκαλο'υνται απ'ο βλ'αβη του εργαλει'ου Σταυρο'ι κειρο'υ Διαστυμο-Παρ'εμβυσμα

PL. GWARANCJA

Narz' dzie jest obj' te gwarancją na wszelkie wady konstrukcyjne i materiałowe, licząc od daty sprzedaży u ytkownikowi i po okazaniu paragonu kasowego. Gwarancją obejmuje wymian' cz'Ąci wybrakowanych. Gwarancją nie znajduje zastosowania w przypadku u ytkowania niezgodnego z normami urzĄdzenia, ani w przypadku szkód spowodowanych działaniami niedozwolonymi lub zaniedbaniami ze strony nabywcy. Gwarancją nie obejmuje szkód powstałych z powodu upadku urzĄdzenia.

SV. GARANTI

Detta verktyg har en avtalsenlig garanti mot konstruktions och materialfel, från och med tidpunkten för användarens inköp och genom uppvisning av kassakvittot. Garantin består i att ersätta de bristfälli-

ga delarna. Denna garanti gäller inte om användningen inte motsvarar apparatens standarder, inte heller vid skador som orsakas av ej tillåtna ingrepp eller på grund av köparens vårdslöshet. Garantin gäller inte förskador som orsakats av att verktyget fungerat bristfälligt.

FI. TAKU

Tämän laitteen takuu on voimassa sopimuksenmukaisesti kattaa kaikki rakente- ja materiaali- ja lukien ostopäivästä kassakuitilla vastaan. Takuu sisältää viallisten osien korvaamisen. Takuu ei korvaa ohjeidenvastaista käyttöä eikä valtuuttamattomien henkilöiden käsittelystä tai ostajan huolimattomuudesta aiheutuneita vahinkoja. Takuu ei vastaa myöskään toimintahäiriöistä aiheutuneita vahinkoja.

RU. Гарантия

Этот инструмент е под договорна гаранция срещу всякакъв дефект в изработката и използваните материали, считано от датата на продажба на потребителя и само срещу представяне на касовата бележка. Гаранционното обслужване се състои в замяна на дефектните части. Настоящата гаранция не е валидна когато апаратът се използва по начин, несъответстващ на стандарта за работа с него, както и в случай на щети, нанесени от неоторизирани лица, или вследствие на проявена небрежност от страна потребителя. Гаранцията не покрива щети, произтекли вследствие на техническа неизправност на апарата.

DA. GARANTI

Dette værktøj er dækket af en garantikontrakt for konstruktions- og materialefejl, som gælder fra købsdatoen ved visning af kassebonen. Garantien består i at udskifte de defekte dele. Garantien dækker ikke fejl opstået som følge af anvendelse, som ikke overholder standarderne for apparatet, eller skader opstået ved ikke autoriserede indgreb eller sløsethed fra brugerens side. Garantien dækker ikke skader opstået, fordi værktøjet har svigtet.

SERVICE APRÈS VENTE - AFTER SALE SERVICE

FARGROUP EUROPE - 192, Avenue Yves Farge - 37700 St. Pierre-des-Corps - FRANCE

fargroup@fargroup.net

GARANTIE - WARRANTY



RO. GARANTIE

Acest aparat este garantat din punct de vedere contractual împotriva tuturor viciilor de construcție și de material, începând de la data vânzării lui către utilizator și la simpla prezentare a bonului de casă. Garanția constă în înlocuirea componentelor defecte. Această garanție nu se aplică în cazul exploataării în alt mod decât cel recomandat de normele aparatului și nici în caz de stricăciuni provocate de intervenții neautorizate sau prin neglijența cumpărătorului. Garanția nu se aplică asupra pagbelor cauzate de o defectare a aparatului.

RU. ГАРАНТИЯ

Данное изделие обладает имеющей силу контракта гарантией, покрывающей все возможные дефекты изготовления и материала. Гарантия вступает в силу с даты продажи изделия пользователю, для этого достаточно сохранить и предъявить полученный в кассе чек. Гарантия обязывает изготовителя заменить дефектные части изделия. В случае не соответствующего нормам использования изделия, несанкционированного демонтажа или ремонта или небрежного обращения действие гарантии прекращается. Гарантия не покрывает ущерб, возникшего в результате сбоев в работе изделия.

TU. GARANTI

Bu araç, satış tarihinden itibaren, kullanıcının sadece vezne alıncısına sunmasıyla tüm üretim ve malzeme hatasına karşı garantilidir. Garanti eksik olan kısımları değiştirmek içindir. Bu garanti aracin şartlarına uygun olmayan işleme durumunda, izin verilmeden kullanımlardan kaynaklanan hasarlarda veya alıcının isteği durumunda uygulanmaz. Garanti malzemenin bir eksikliğinden meydana gelen bir zararda uygulanmaz.

CS. ZÁRUKA

Pro tento nástroj platí smluvní záruka na všechny výrobní a materiálové vady od data prodeje uživateli a na základě předložení pokladničního bloku. Záruka spočívá ve výměně vadných částí. Tato záruka neplatí v případě použití přístroje, které neodpovídá normám, ani v případě škod způsobených nepovolenými zásahy nebo nedbalostí ze strany kupujícího. Záruka se nevztahuje na škody způsobené závadou nástroje.

SK. ZÁRUKA

Pre tento nástroj platí zmluvná záruka na všetky výrobné a materiálové chyby od dátumu predaja užívateľovi a na základe predloženia pokladničného bloku. Záruka spočíva vo výmene chybných častí. Táto záruka neplatí v prípade použitia prístroja,

ktoré nezodpovedá normám, ani v prípade škôd spôsobených nepovolenými zásahmi alebo nedbalosťou zo strany kupujúceho. Záruka sa nevzťahuje na škody spôsobené poruchou nástroja

HE. אחריות

עם הצגת החשבונית קופה. האחריות-משמעה ביצור או בחומר, החל מיום המכירה למשתמש עלכלי זה חלה אחריות לפי חוזה מפורסם כל ליקוי ובמקרה של נזק שנגרם על ידי התערבותו תללא הי במקרה של שימוש במשך שנים מתימים לתקנים בכלי. החלף תחלקם הקלויים אחריות זו אינה חלה האחריות אינה חלה על נזק שנגרם על ידי תקלה סמכות או על די השלנות ממת הקונה.

AR. الضمان

وبناء على مجرد تقديم بطاقة الشراء يتدخل في عوفى الجواد. إختياراً من تاريخ البيع الى البستعمل هذه الة مخرجة تاعدياً من أي عيب فنى التصني لمعايير الجهاز. ولا في حالة تعرضه للإتلافات إن وأياً للتطبيقي في حالة الاستخدام غير المطابق فاني سبدال الأجزاء العاطلة لا يكون هذا الضمان لا ينطبق الضمان على الخرد الناتج عن غل الضمان تدغل غير مدرجة أو في حالة الإبدال من قبل البشري ناتجة عن عمليات

HU. GARANCIA

Erre a szerszámra szerződéses garanciát vállalunk bármilyen gyártási és anyaghiba felmerülése esetére, a fogyasztó részére történt eladás napjától számítva, a pénz-tárgyi blokk egyszerű felmutatása ellenében. A garancia a hibás alkatrészek cseréjére terjed ki. Ez a garancia nem érvényes, ha a készüléket nem rendeltetésszerűen használták, sem illetéktelen beavatkozások, vagy a vásárló hanyagsága okozta árok esetén. A garancia nem fedezi azokat a károkat, melyeket a szerszám hibás működése okozott.

SL. GARANCIJA

To orodje je z garancijsko pogodbo zaščiteno proti vsem napakam v izdelavi in v sestavnem materialu od datuma prodaje naprej in ta velja ob predložiti blagajniškega računa. Garancija velja za zamenjavo delov z napako. Ta garancija ne velja za uporabo orodja, ki ni v skladu z normami, predpisanimi za omenjeno orodje in za primere okvar, ki nastanejo zaradi nedovoljenih posegov na orodju ali zaradi malomarnega rokovanja kupca. Garancija ne velja za škodo, ki jo lahko povzroči okvara orodja.

ET. GARANTIJA

See tööriist kuulub lepingu järgi garantiiremonti arvestades alates müümise päevast ja kassatšeki alusel kasutatjale kõigi konstruktsiooni- ja materjalivigade puhul. Garantii seisneb defektsete osade väljavahetamises. See garantii ei kehti aparaadi normide ebatavalise eiramise puhul ega ostja poolt keelatud viisil kasutamisest või hooletusjätmisest tulenevate kahjude korral. Garantii ei kehti seadme defektidest põhjustatud kahjude puhul.

LV. GARANTIJA

Šis prietaisas yra užtikrinamas kaip itin geros kokybės, nuo jo pardavimo datos iki jo panaudojimo, ir jam yra suteikiamas garantinis talonas. Garantijos metu galima pakeisti atsiradusius trumplataikius gedimus. Ši garantija netaikoma esant netinkamam naudojimui ar nesilaikant

reikiam šio aparato vartojimo instrukcijų, tai pat pačiam pirkeiui ji sugadinus. Garantija taip pat netaikoma, prietaisą naudojant ne pagal paskirtį ir jį apgadinus

LT. GARANTIJA

Šim darbarikam ir ligumà neteikta garantija visiem defektiūm, kas saistàs ar konstrukcijū n materiàliū, sàkøt ar pàrdošanos datumu, kad mašinū pàrdøt lietotàjam un vienkàrši uzràdøt kases çeku. Garantija iekļauj bojàto daļu nomaiņu. Ši garantija nav derīga, ja aparātš nav lietots saskaņā ar drošības noteikumiem, ne gadījumos ja bojājumi radušies nesankcionētas iekļaušanās gadījumā vai arī pirceja nolaidības dēļ. Garantija nav derīga, ja bojājumi radušies darbarika defekta dēļ

HR. JAMSTVO

Ovaj alat ima ugovorno jamstvo u slučaju bilo kakvih nedostataka u konstrukciji i materijalu, od datuma prodaje korisniku uz jednostavno predocenje računa. Jamstvo se sastoji u zamjeni neispravnih dijelova. Ovo se jamstvo ne primjenjuje u slučaju uporabe i eksploatacije koja nije sukladna standardima uređaja, niti u slučaju štete uzrokovane neovlaštenim intervencijama ili nemarom kupca. Jamstvo se ne primjenjuje na štetu uzrokovanu nekim nedostatkom alata.

SERVICE APRÈS VENTE - AFTER SALE SERVICE

FARGROUP EUROPE - 192, Avenue Yves Farge - 37700 St. Pierre-des-Corps - FRANCE

fargroup@fargroup.net



FAR GROUP EUROPE

Une société du groupe **SIGMA**

192, Avenue Yves Farge
37700 St. Pierre-des-Corps
FRANCE

fartools.com

